

FICHAS-1

AMESA

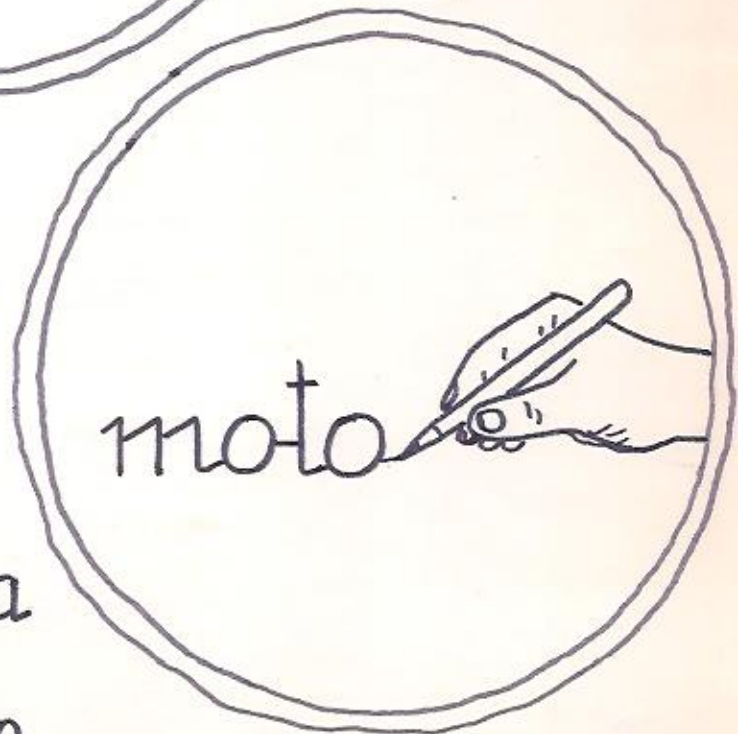

método de
lectura y escritura
AMESA

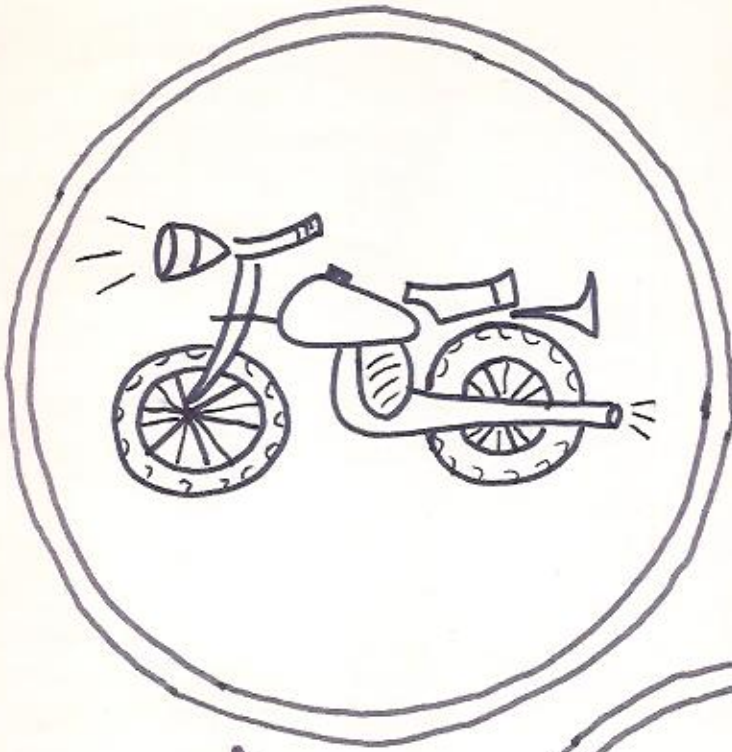
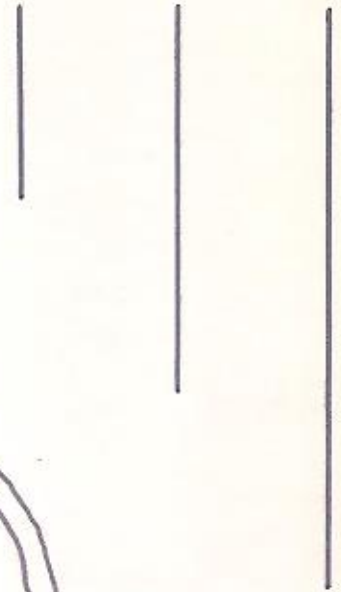



VOCALES

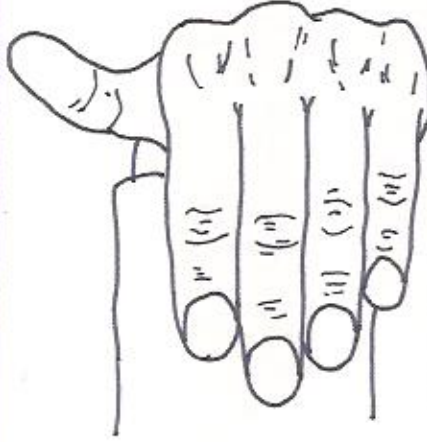

M



P



T



L



S

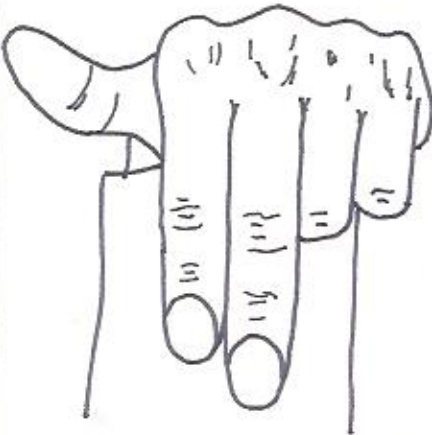

N



D



F

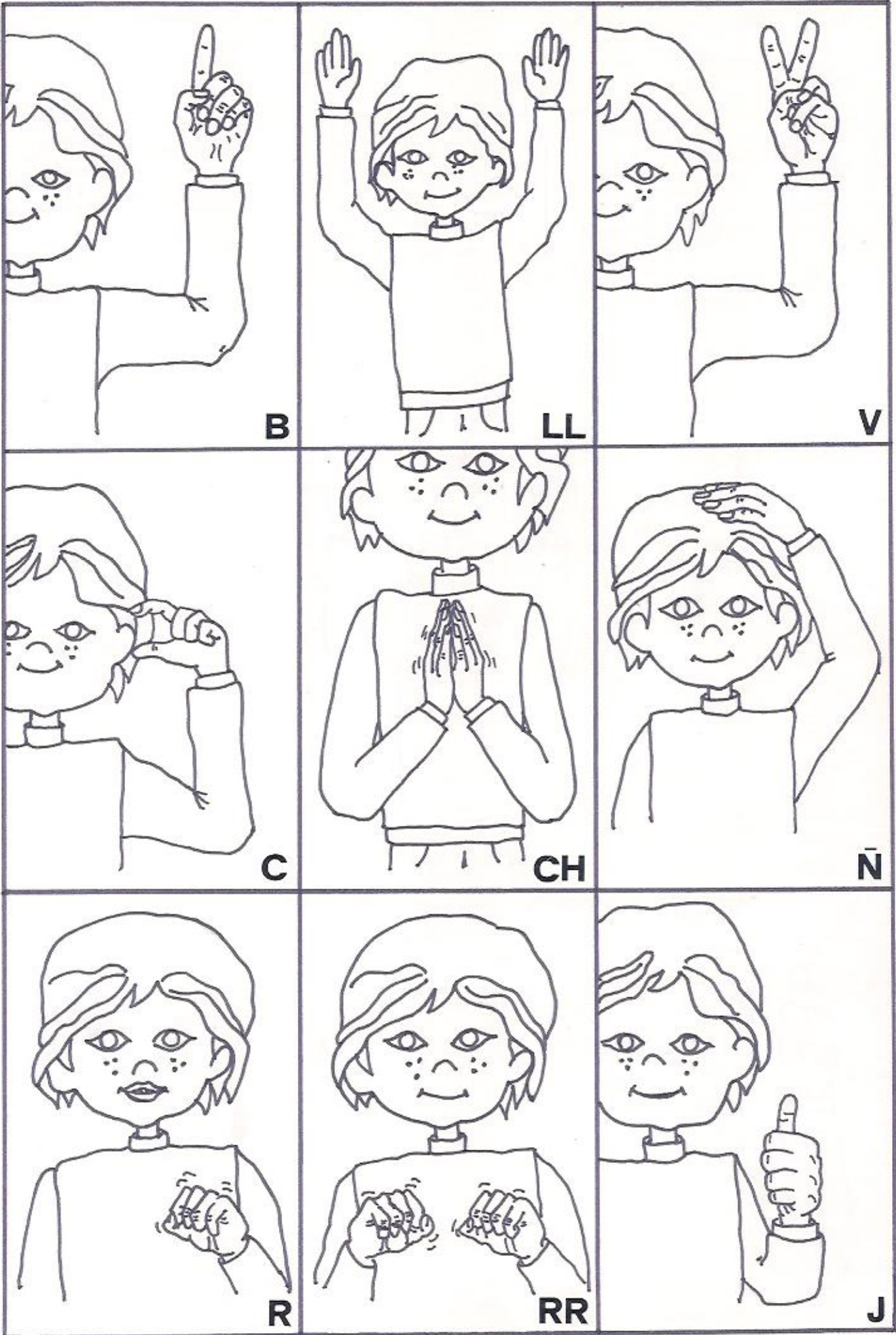

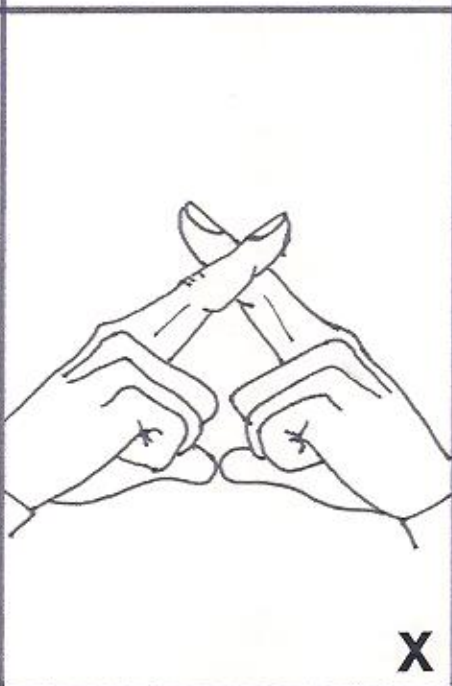
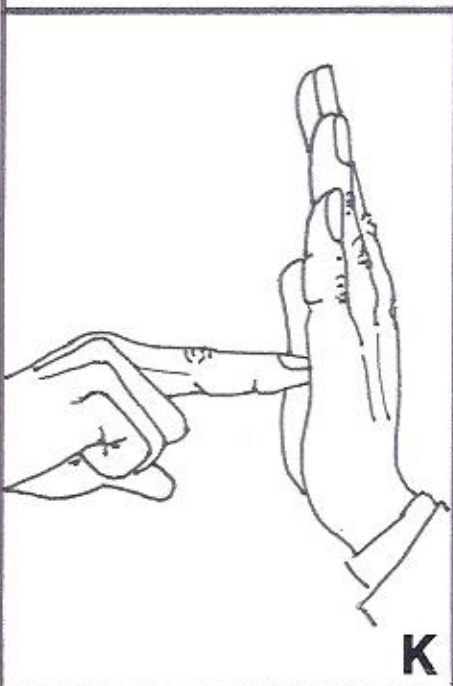
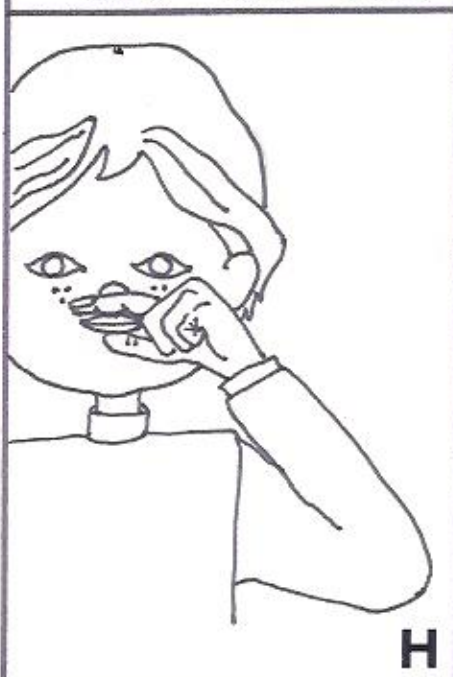
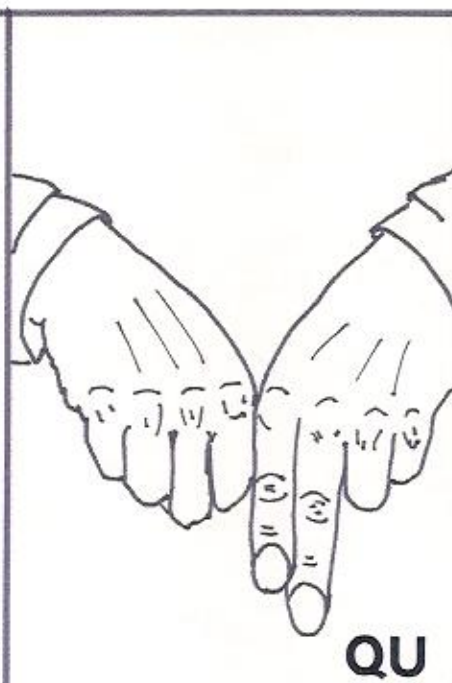
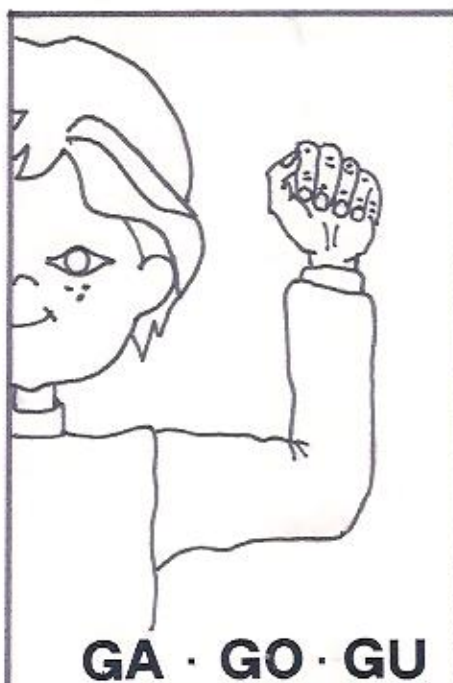

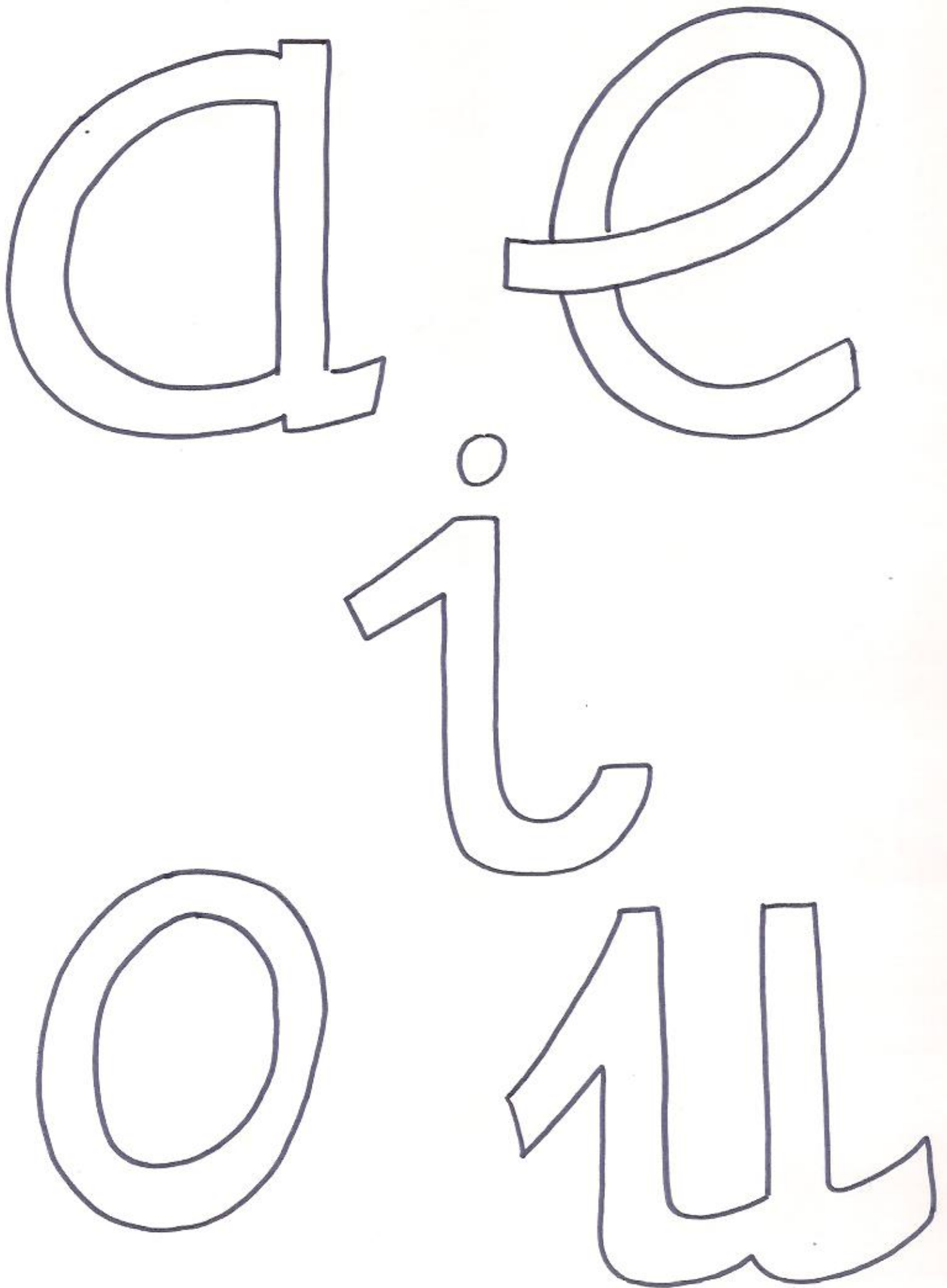

ma me mi mo mu

mi mamá me mima

amo a mi mamá

dictado

ma

me

mi

mo

mu

mamá papá pio amo
pipa mio pipo mimo

↓
m

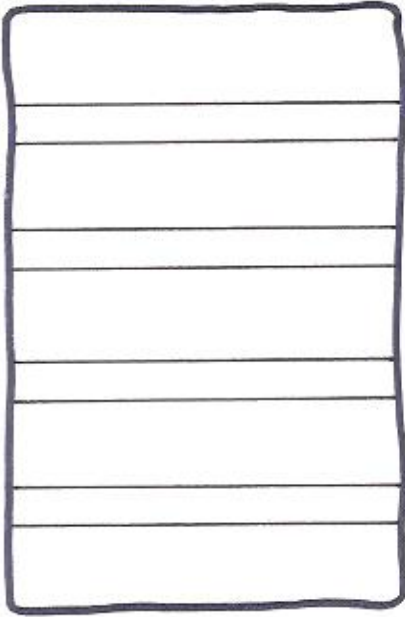

↓
n

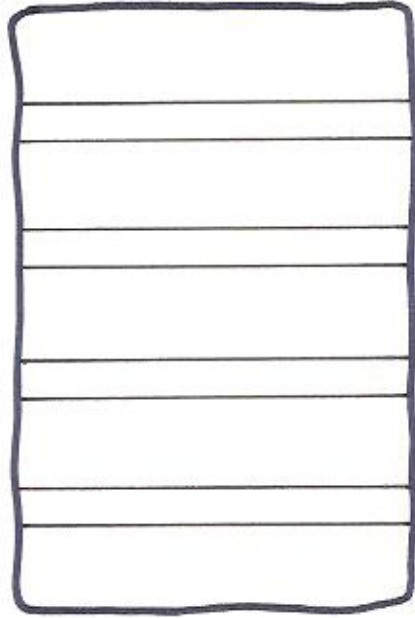

dictado

pa	pe	pi	po	pu
----	----	----	----	----

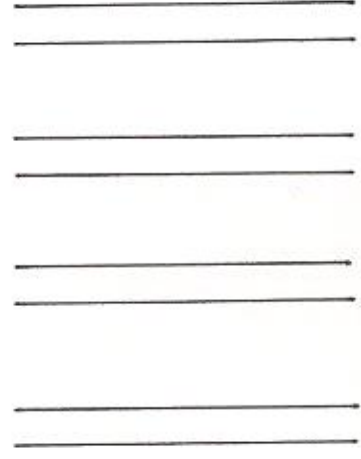
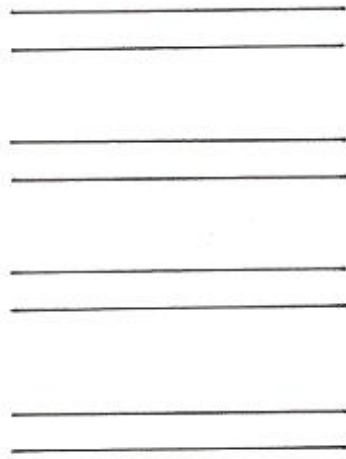
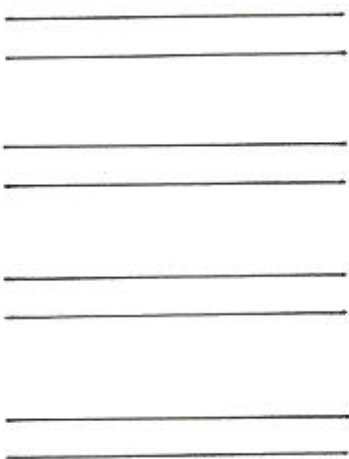

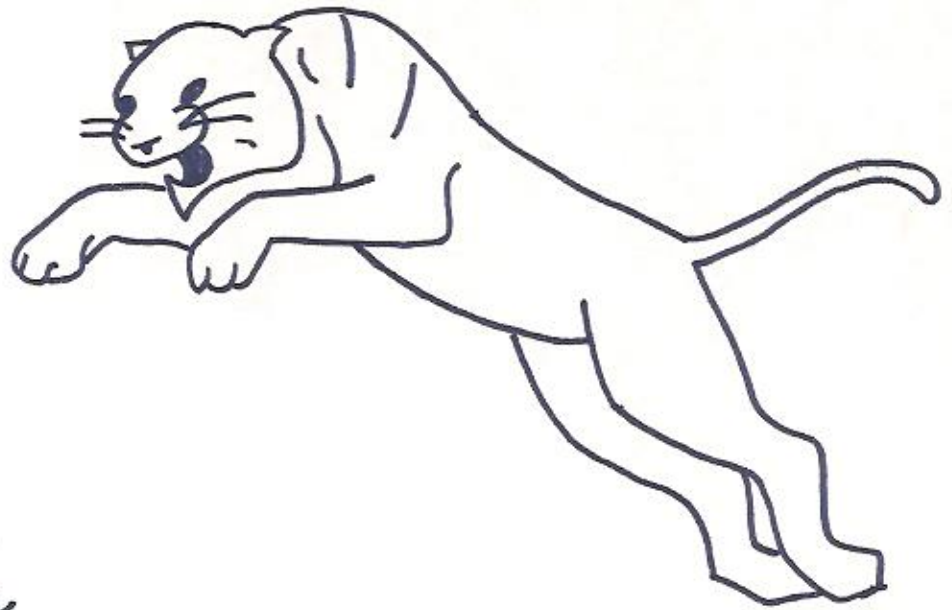

mamá

puma

mapa

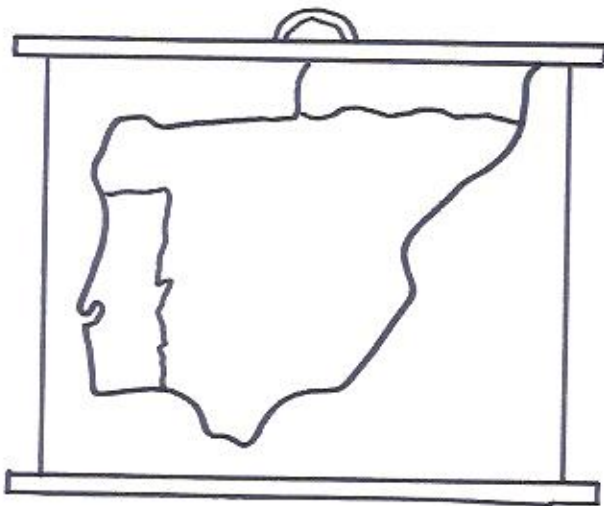

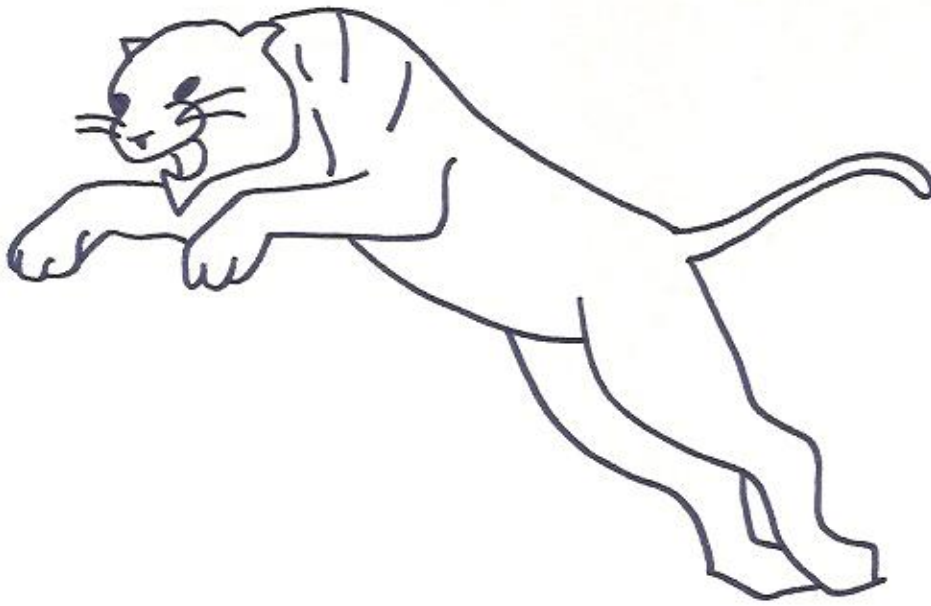

pum -



mam -

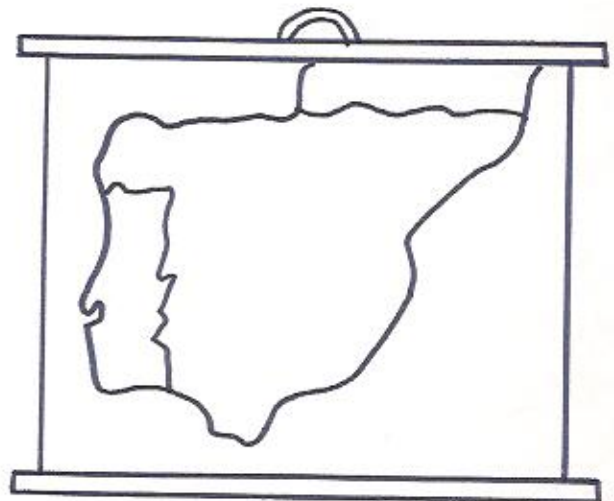

map -

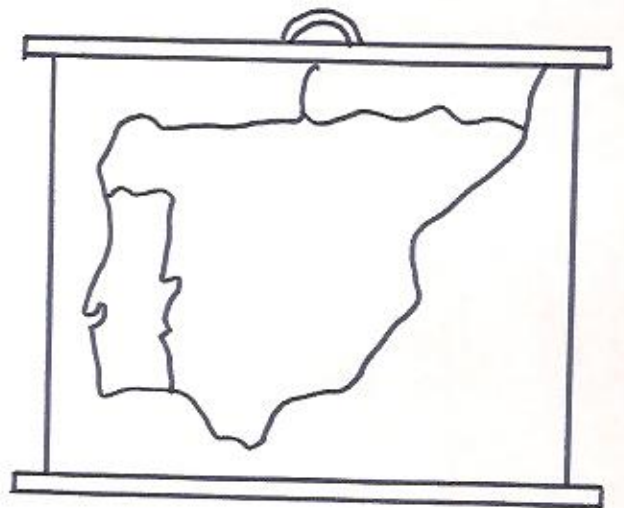
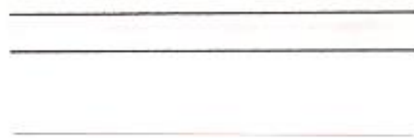
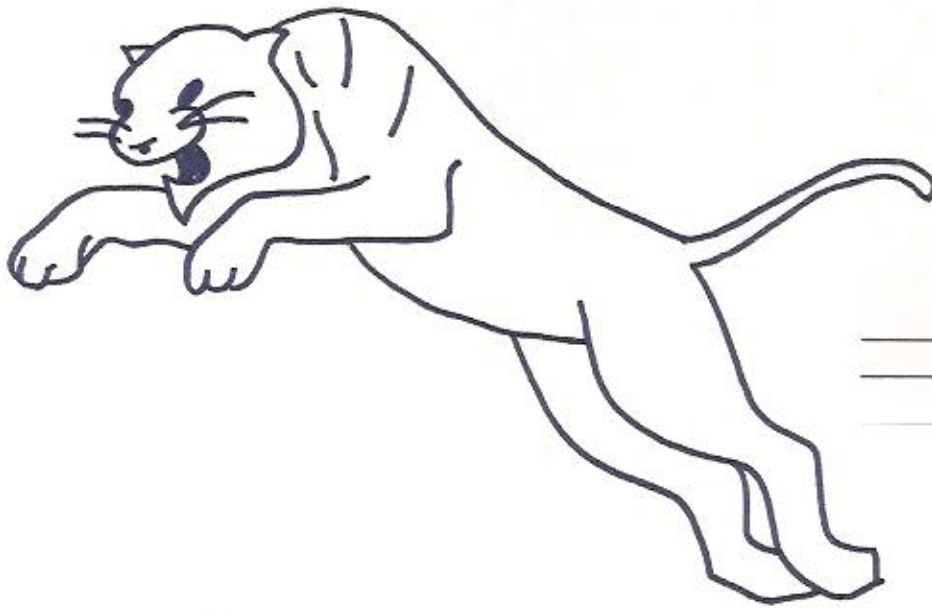

puma tío toma mapa
moto pipa timo papá

↓
p

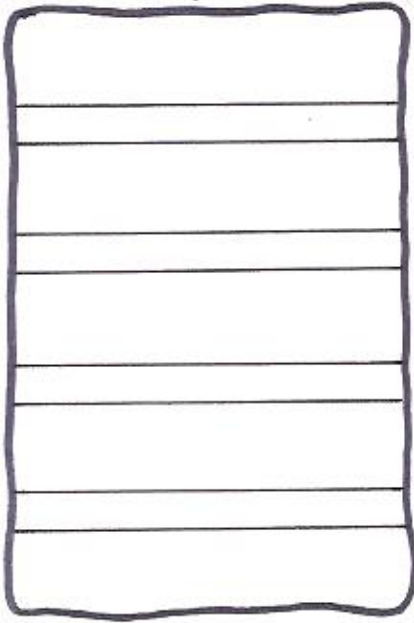

↓
t

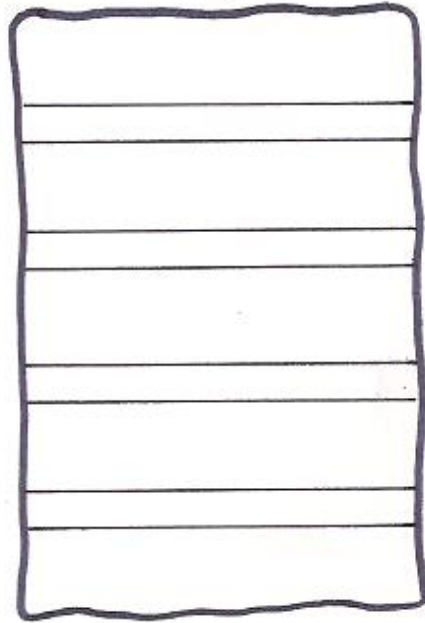

dictado

ta	te	ti	to	tu
----	----	----	----	----

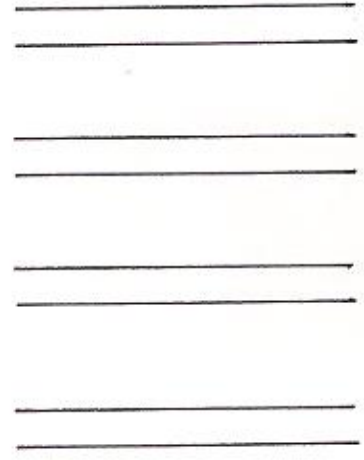
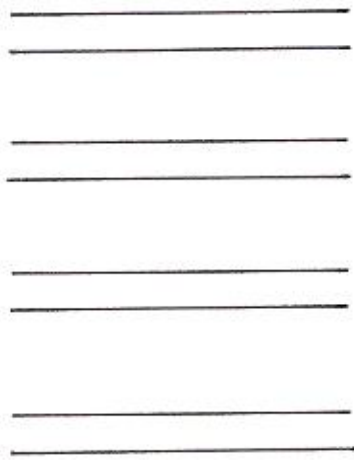
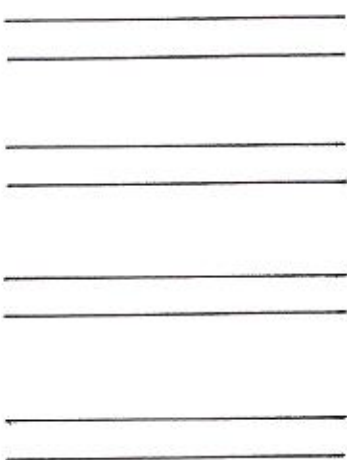

moto

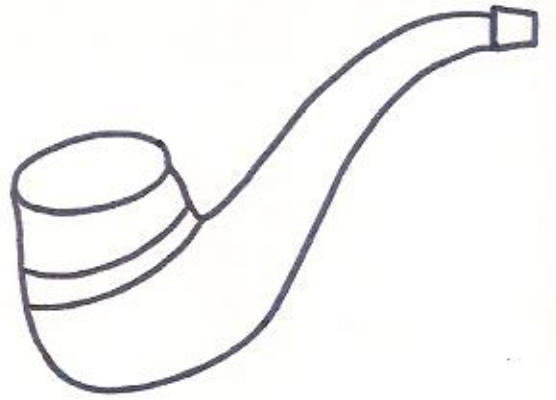

pipa

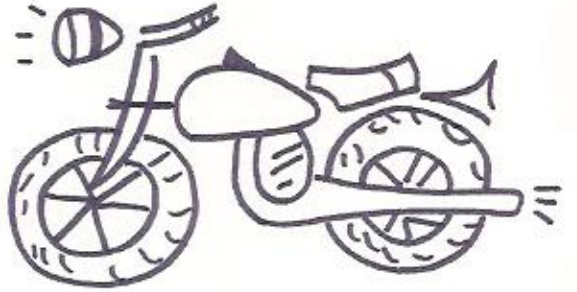

pato

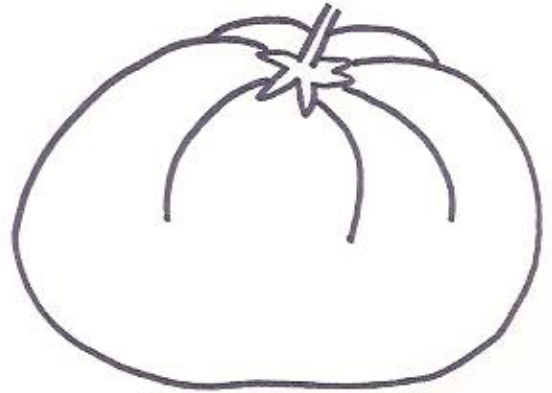

patata

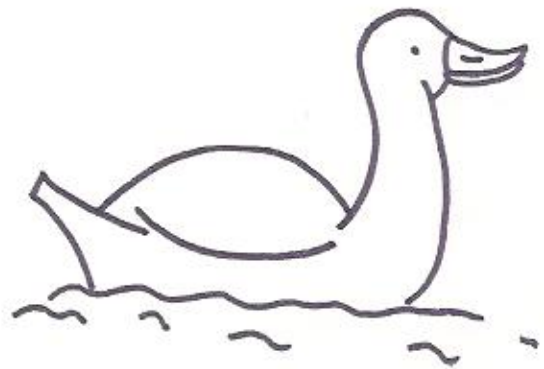

tomate

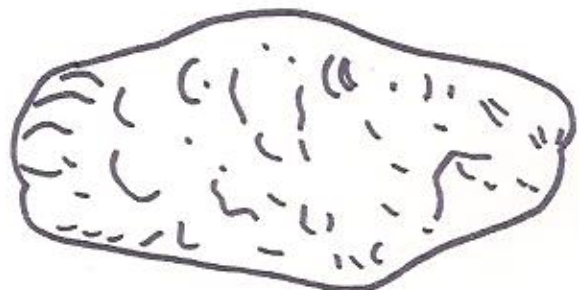

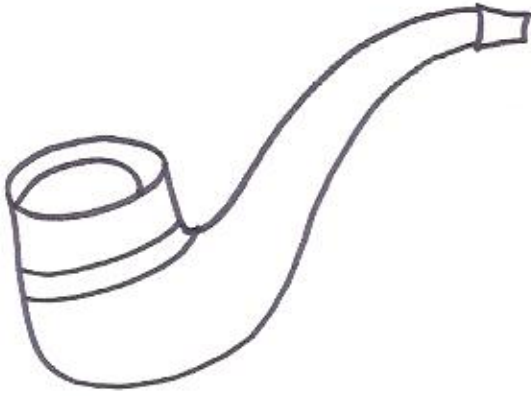

pip_

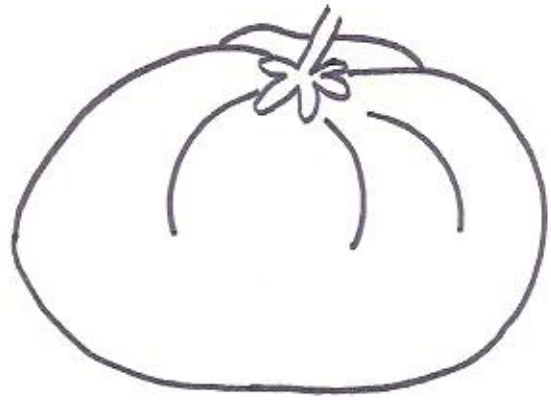

tom_te

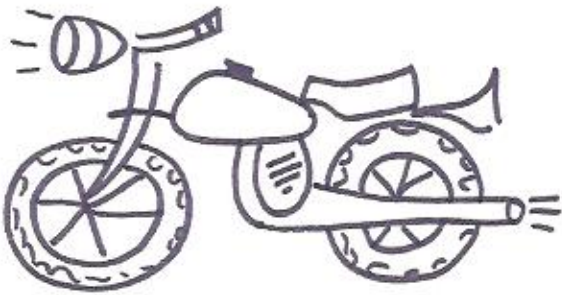

m_to

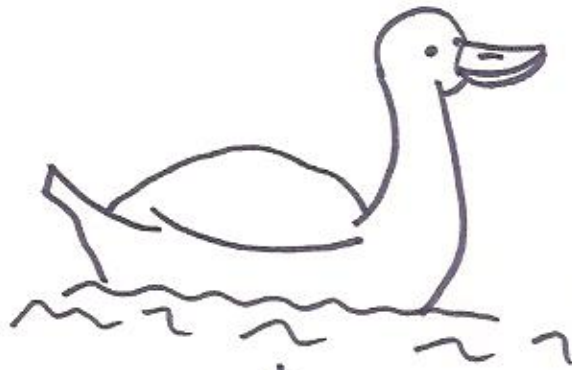

pat_

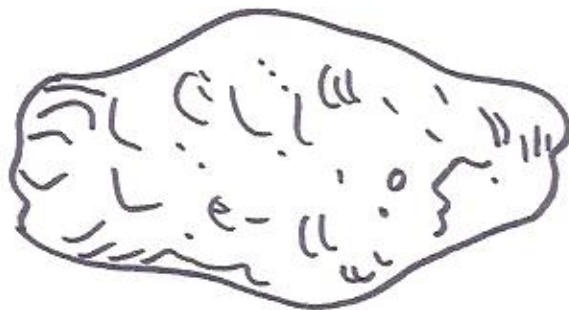

pat_ta

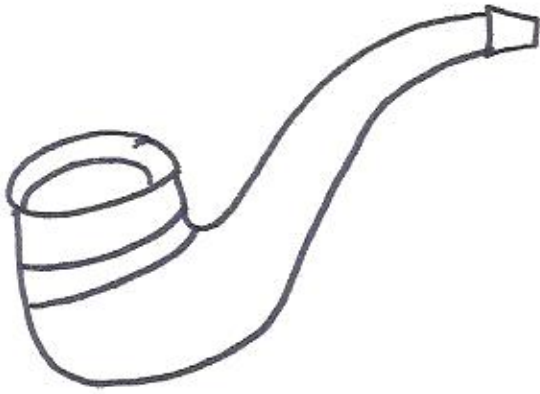

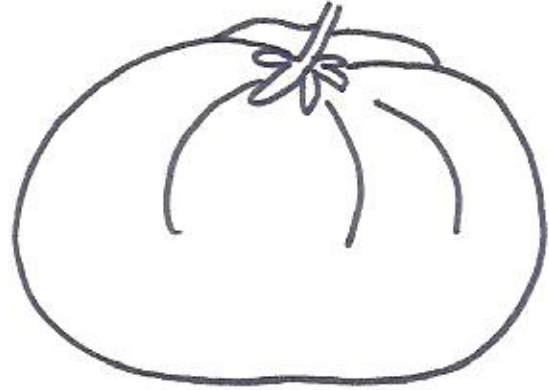

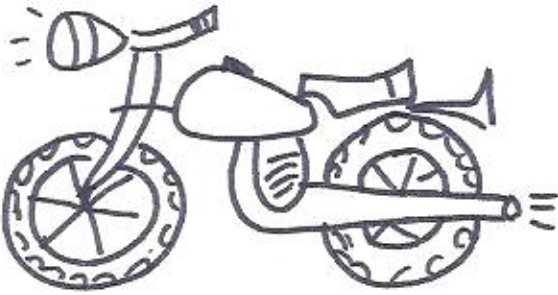

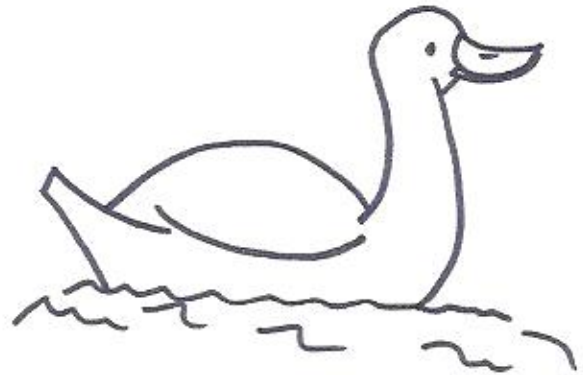



pelo toma pito palo
paloma moto patata lomo

t

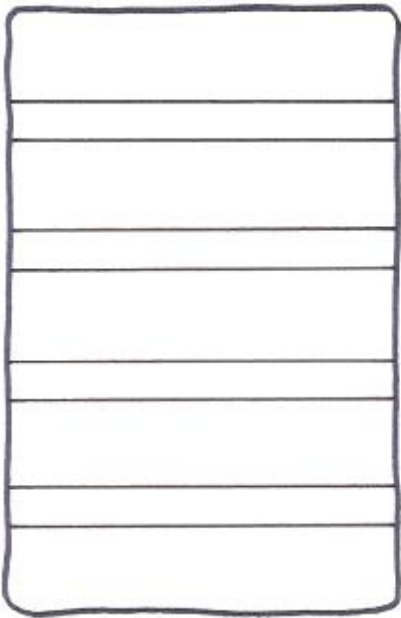

l

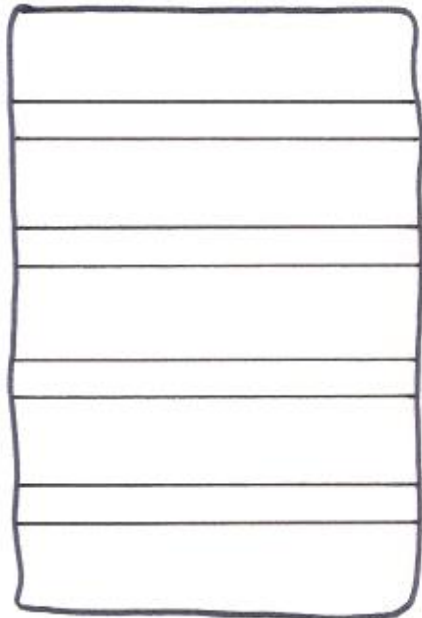

dictado

la	le	li	lo	lu
----	----	----	----	----

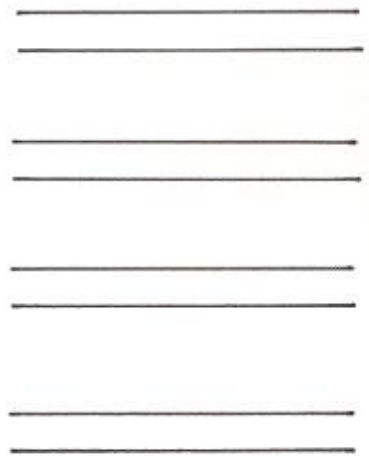
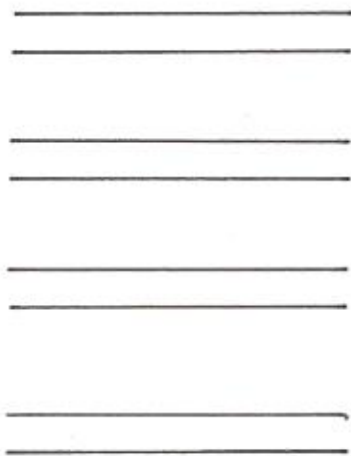
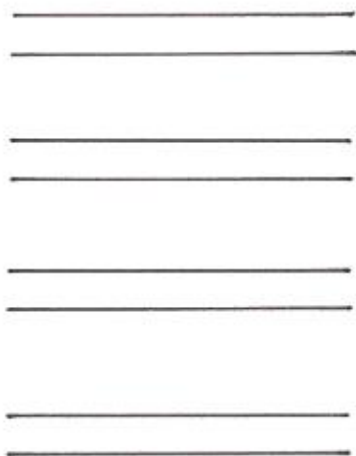

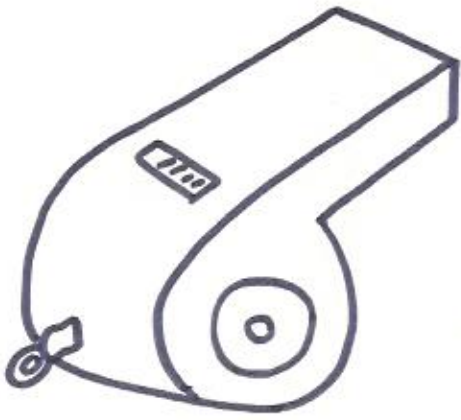

pie

pelota

pito

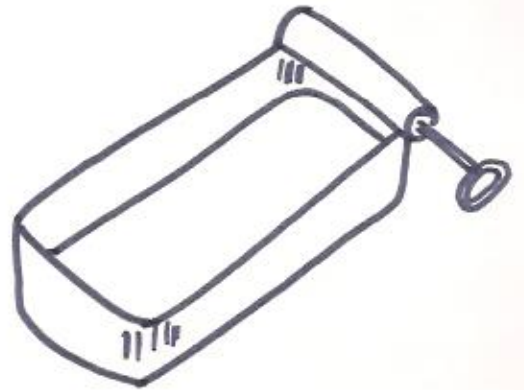
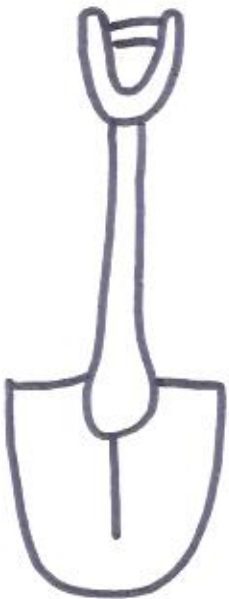

lata

pala

maleta

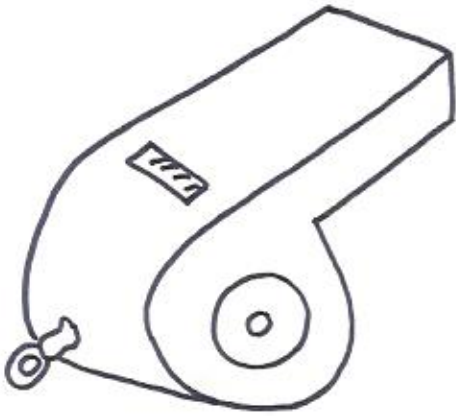

me-tro

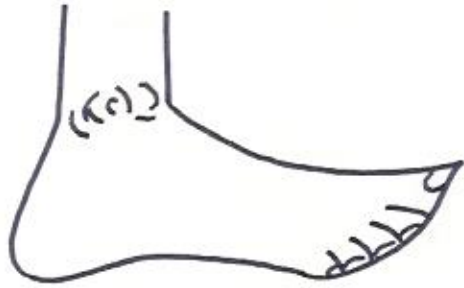

pie



pelota



maleta

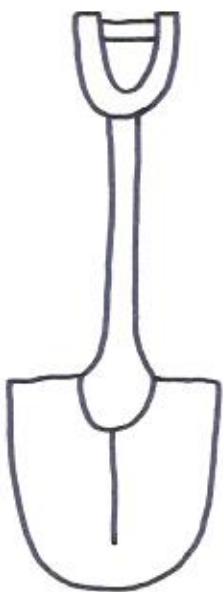

pala

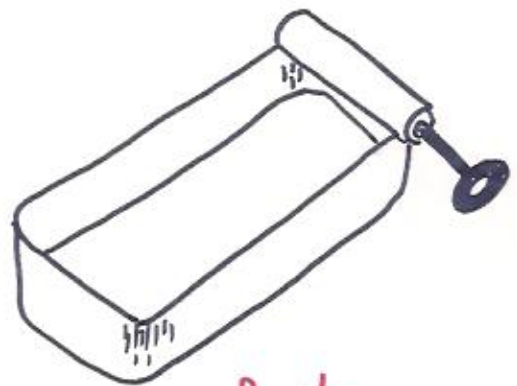

caja

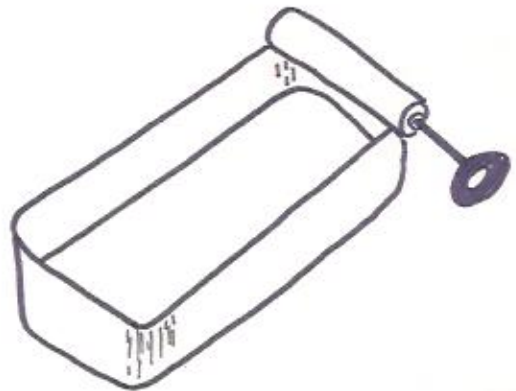
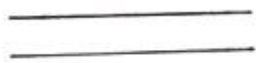
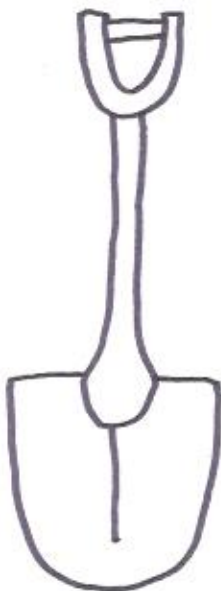
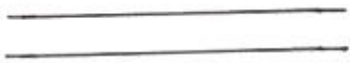
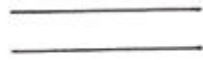
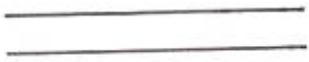
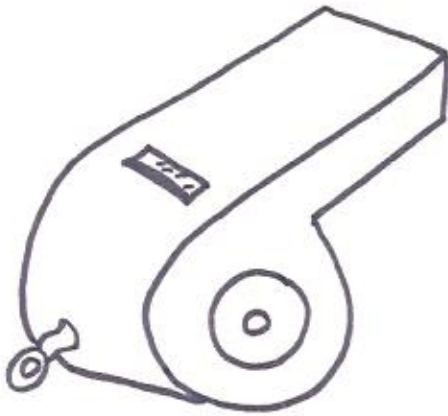

sapo seta lata palo
pelo oso suma tila

↓
l

↓
s

dictado

sa	se	si	so	su
----	----	----	----	----

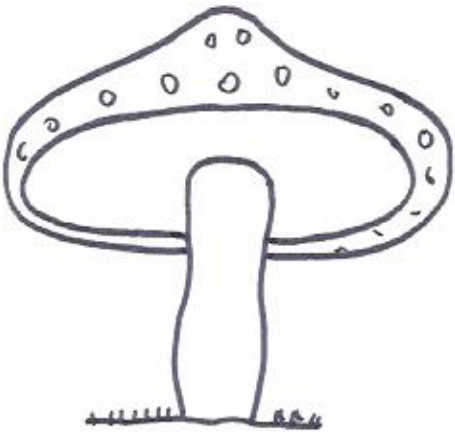

$$\begin{array}{r} 4 \ 5 \ 6 \\ + 1 \ 9 \ 4 \\ \hline 7 \ 3 \ 8 \end{array}$$

sapo

suma

seta

peseta

oso

mesa

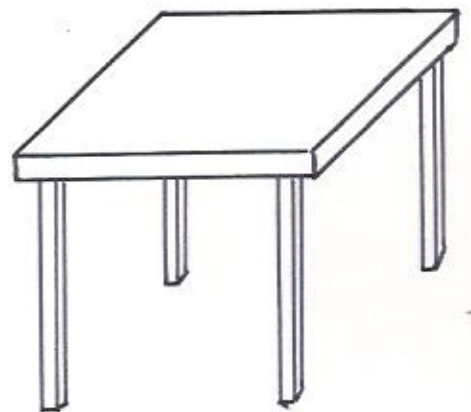

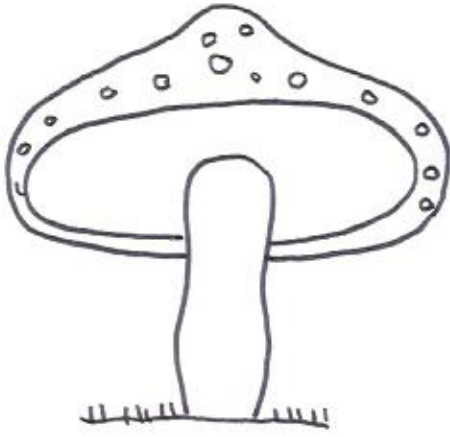

set_



s_ _po

$$\begin{array}{r} 4\ 5\ 6 \\ +\ 1\ 9\ 4 \\ \hline 7\ 3\ 8 \end{array}$$

s_ _ma



pes_ _ta



os_ _

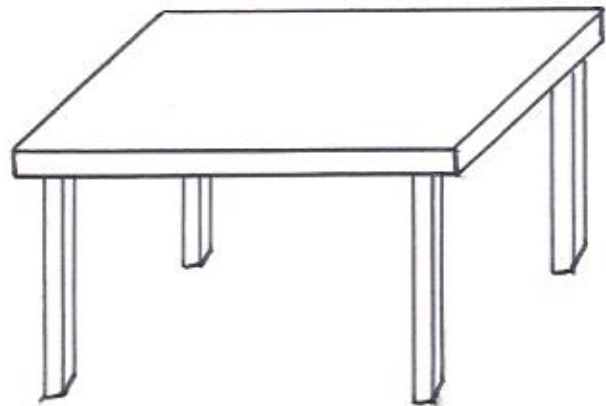

mes_ _

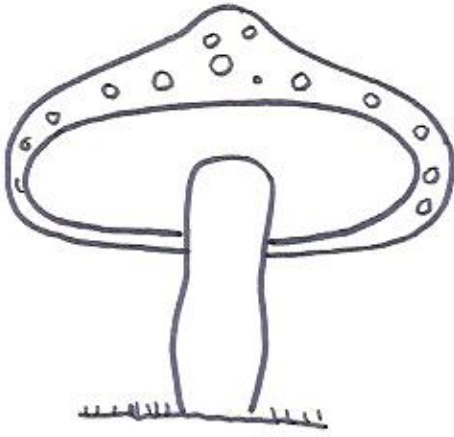

==

$$\begin{array}{r} 456 \\ + 194 \\ \hline 738 \end{array}$$

==

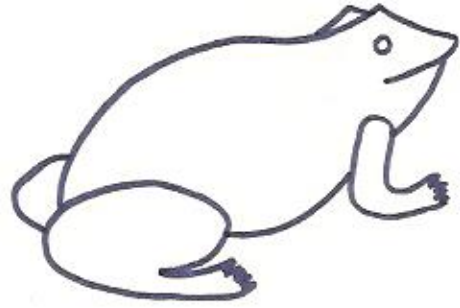

==



==



==

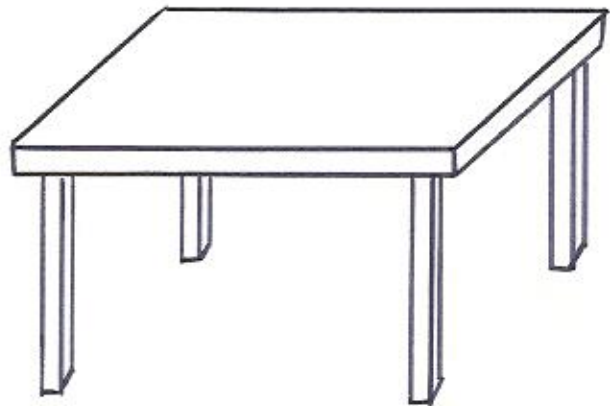

==

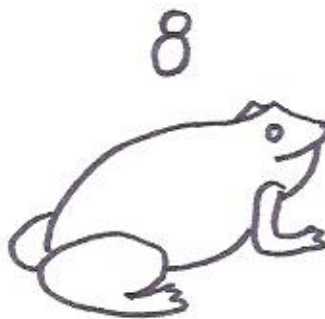
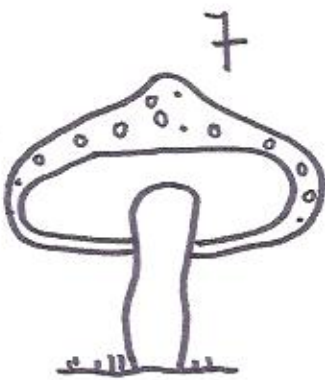
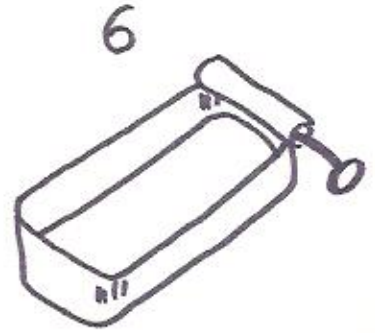
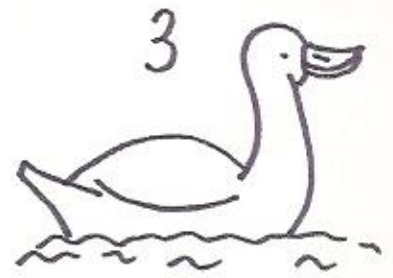
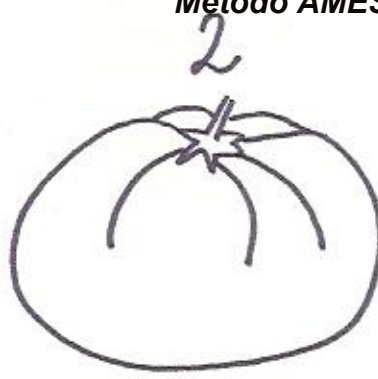
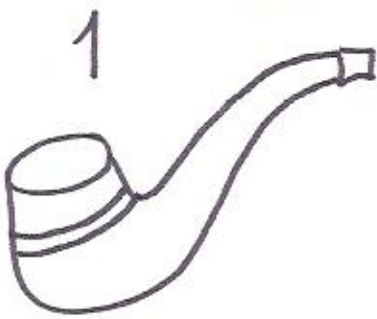

auto-dictado

1. _____

4. _____

7. _____

2. _____

5. _____

8. _____

3. _____

6. _____

9. _____

mano silo saeta mono
piano sébola enano sala

↓
3

↓
12

dictado

na	no	ne	ni	nu
----	----	----	----	----

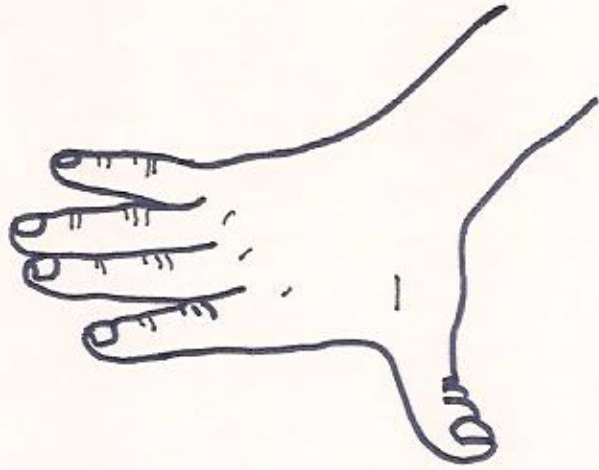
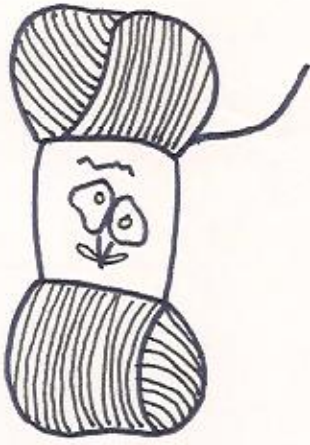

mano

lana

peine

mono

enano

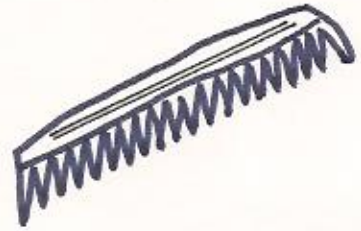

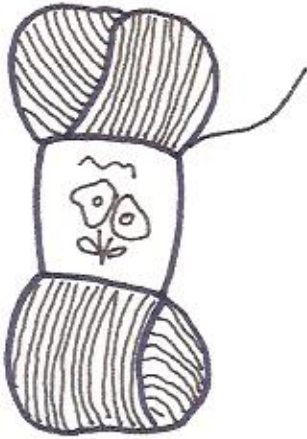

lan_

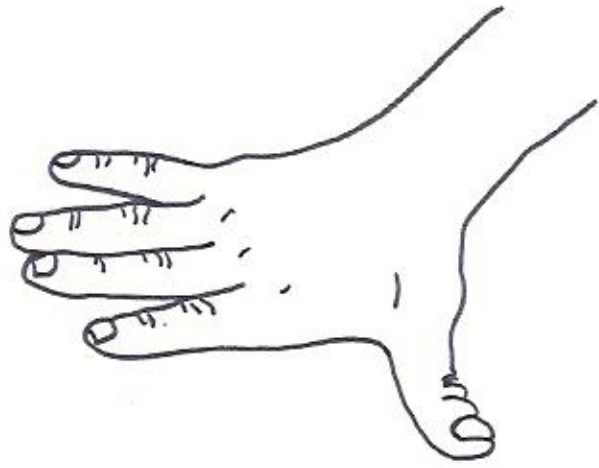

man_



pian_



mon_

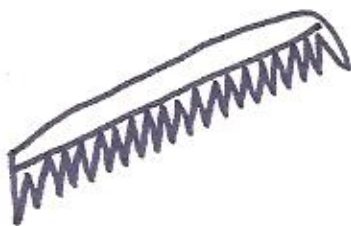

pein_



en_n_

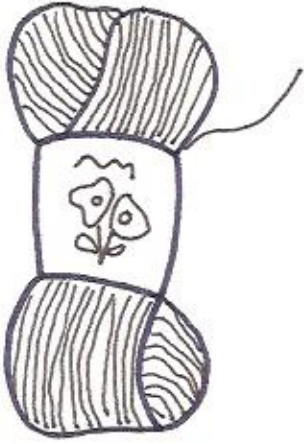

==

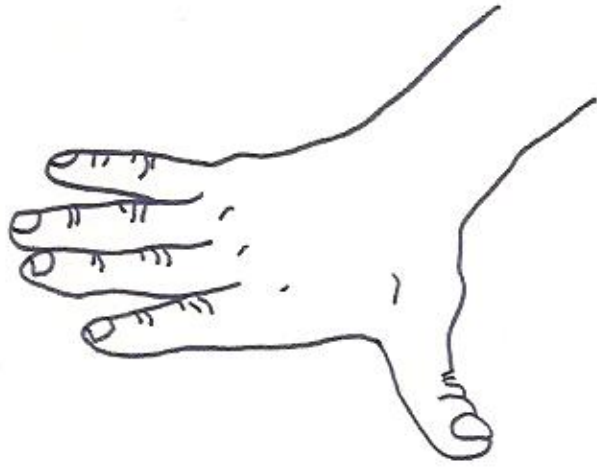

==

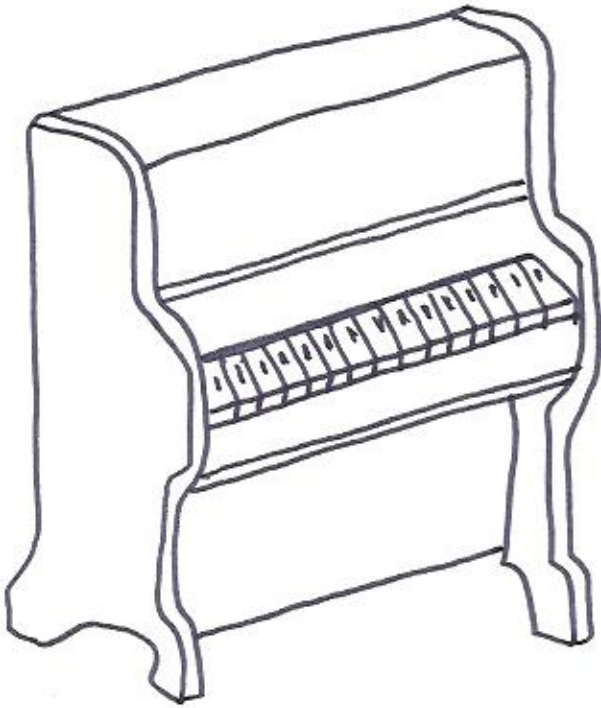

==



==

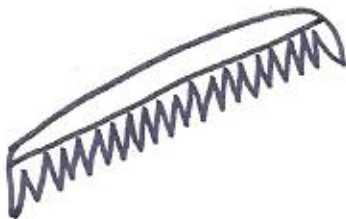

==



==

dedo lana mina dado
tiene deseo todo nieta

↓
n

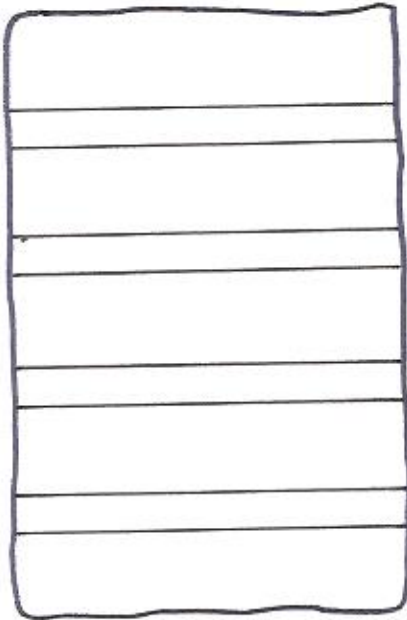

↓
d

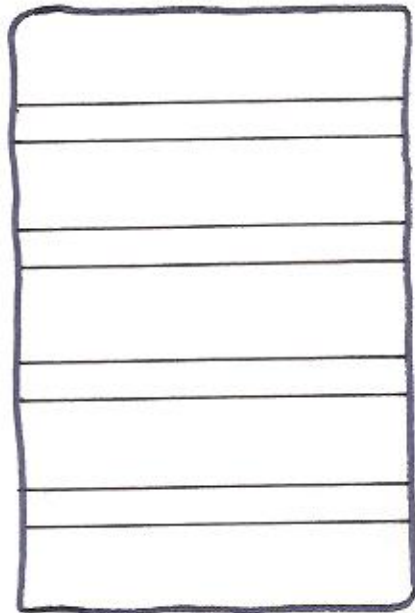

dictado

da	de	di	do	du
----	----	----	----	----

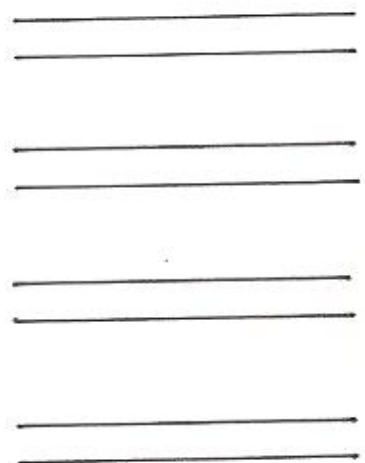
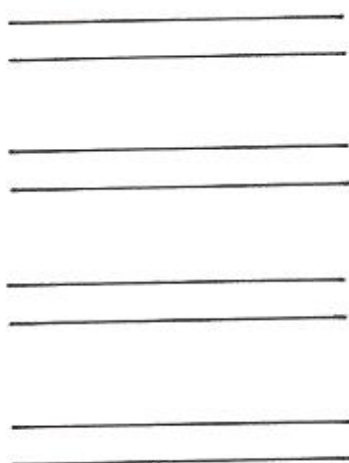
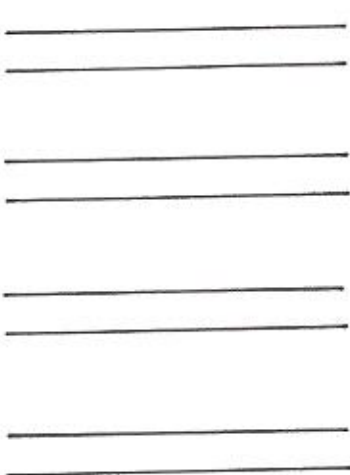

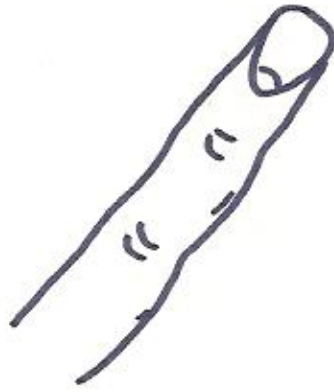
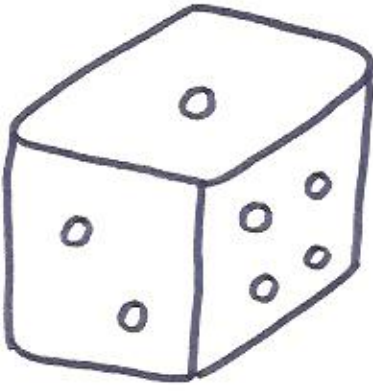

molino

dado

dedo

nido

luna

pomada

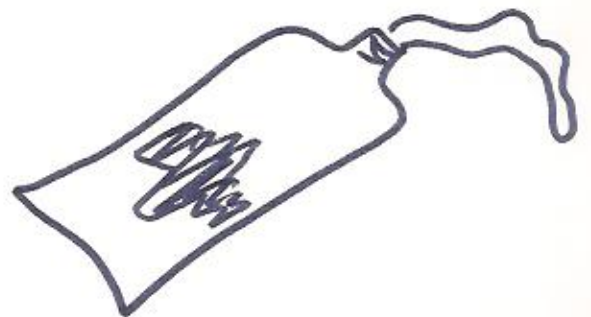

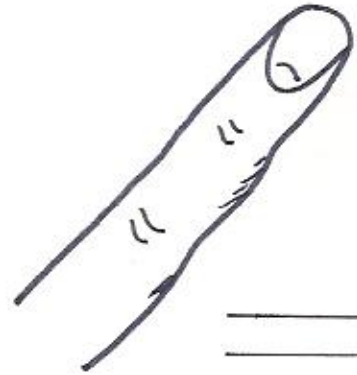
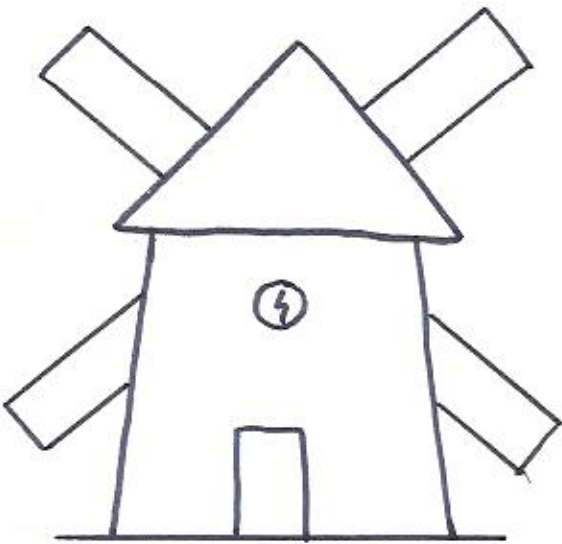
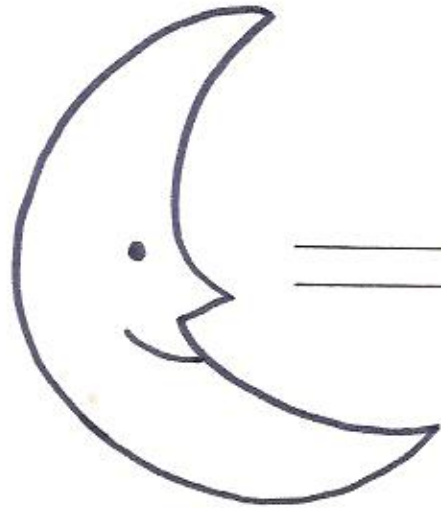
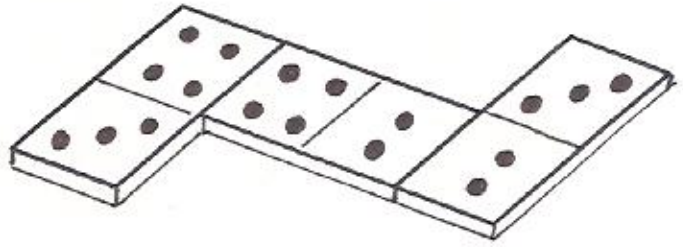
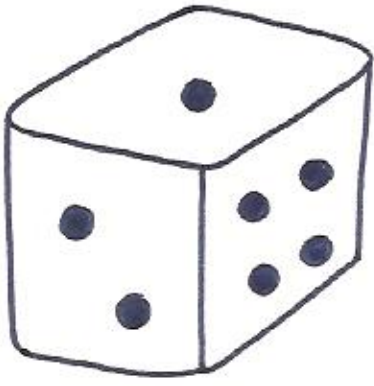

moneda sofá foto medida
fila filete duda dime

d

f

dictado

fa	fe	fi	fo	fu
----	----	----	----	----



lima

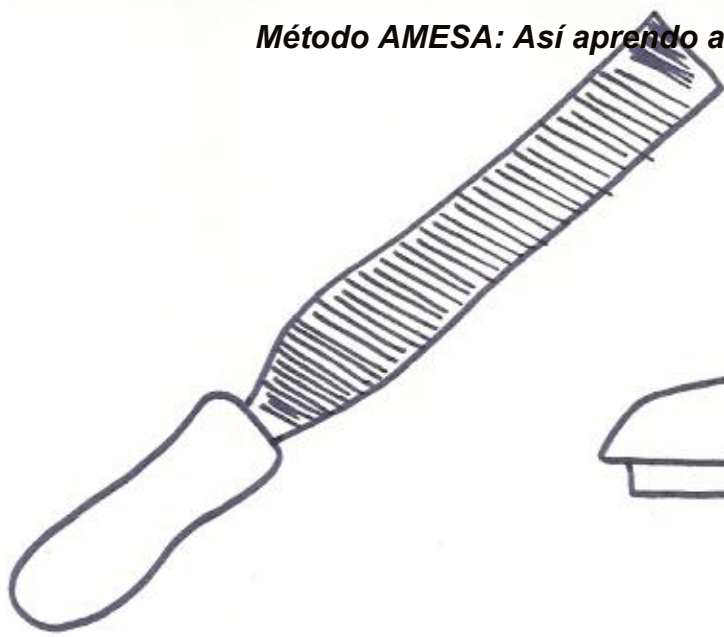

fuma



tapa

sofá

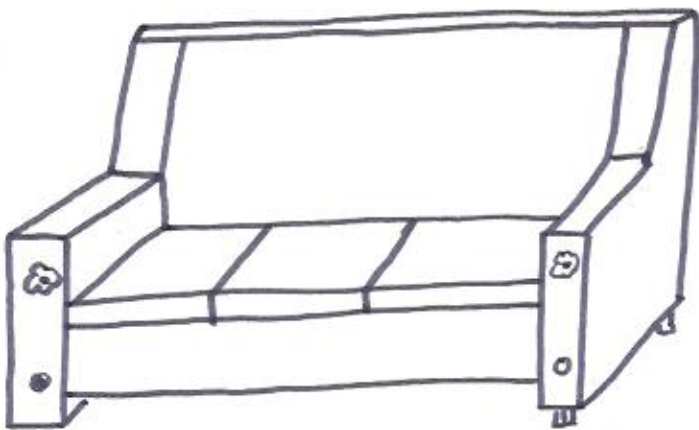

teléfono

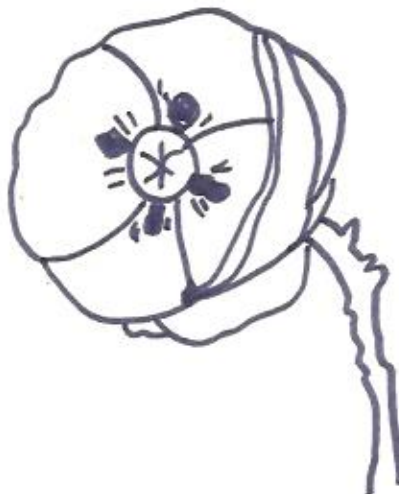

amapola



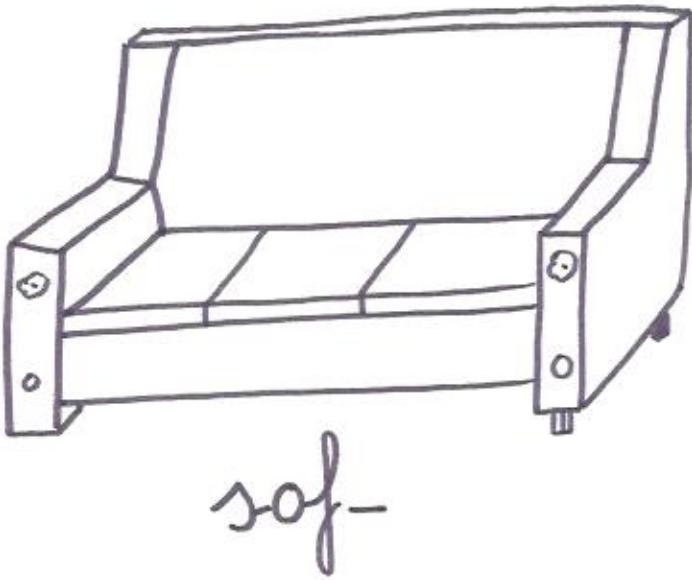
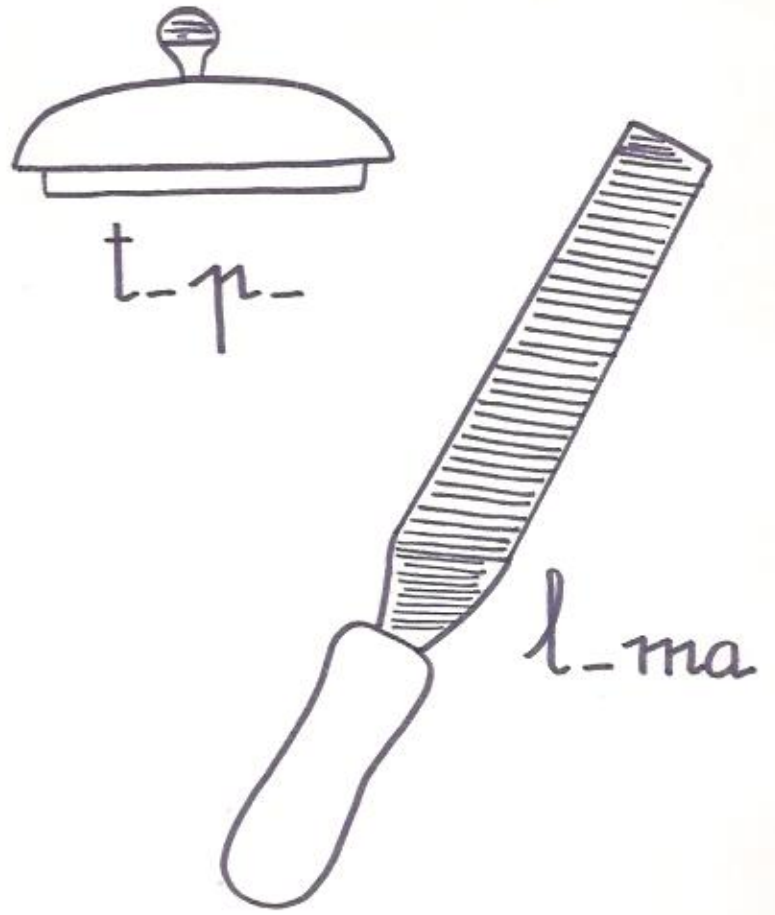

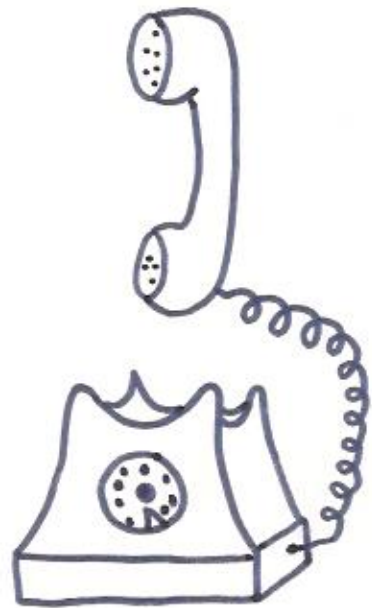
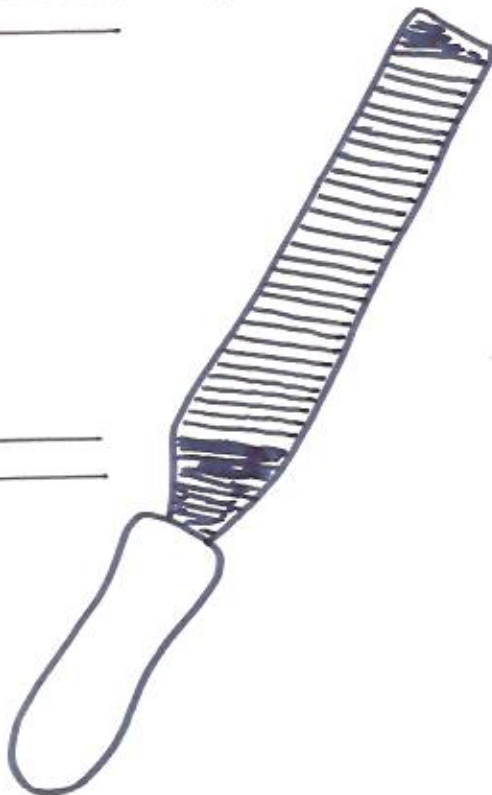
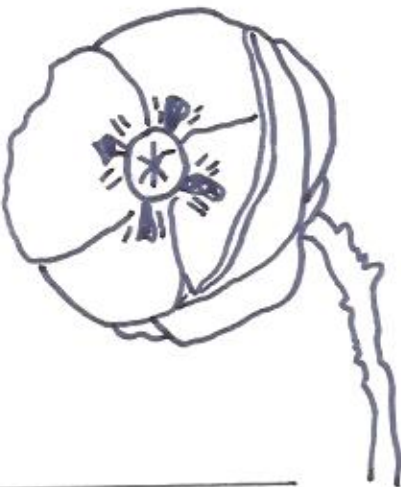
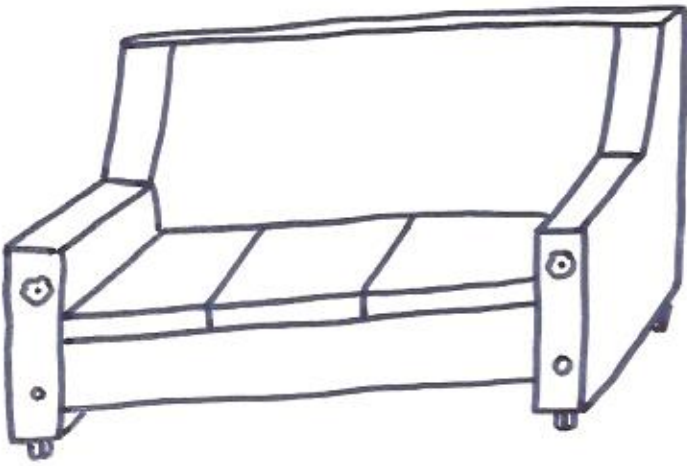

1

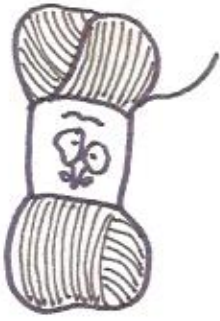

2



3

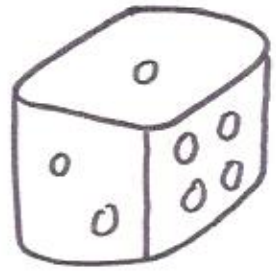

4



5



6



7



8



9

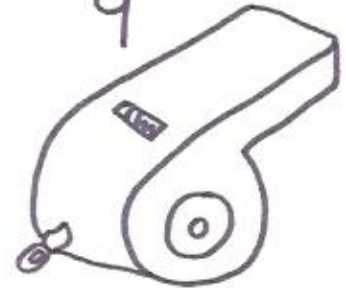

autodictado

1- _____

4- _____

7- _____

2- _____

5- _____

8- _____

3- _____

6- _____

9- _____

familia teléfono bala feo
baile faena boda bola

f

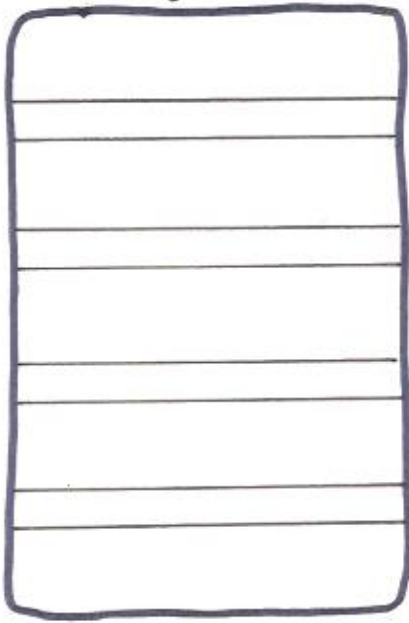

b



dictado

ba

be

bi

bo

bu

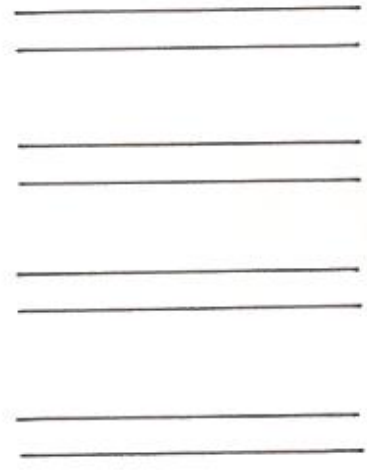
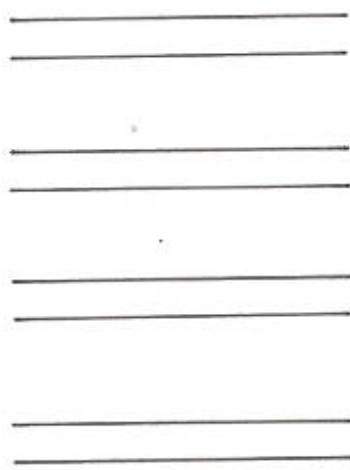
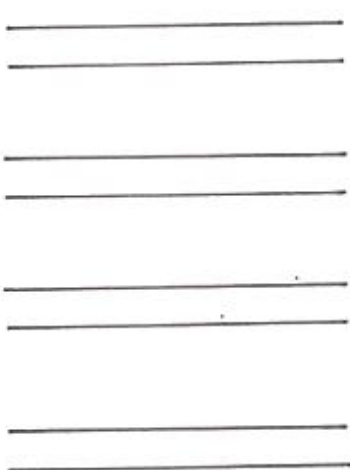

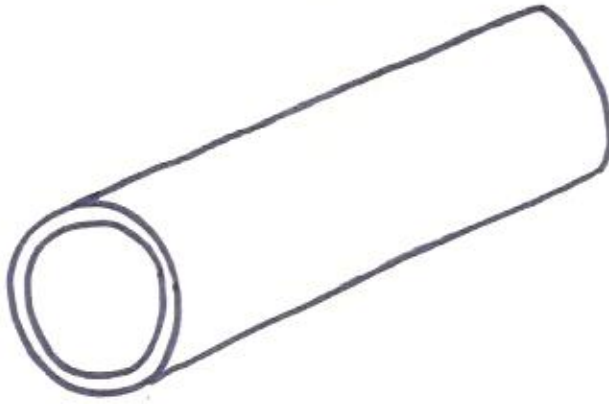

tubo

bola

bota

bala

nube

bote

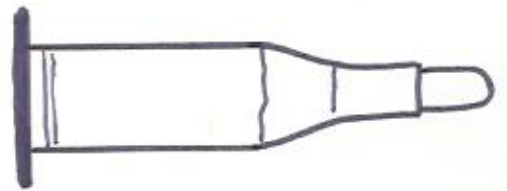



b_ta

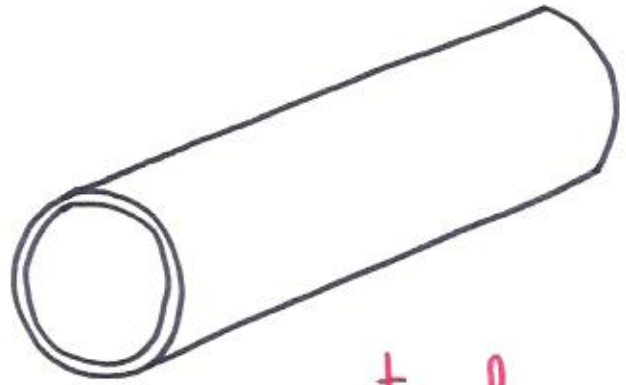

tub_



lob_

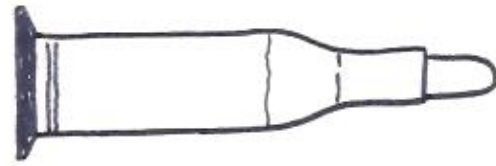

b_la



nub_



nab_



b_te



b_la

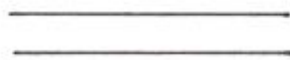
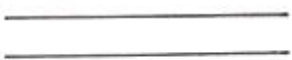
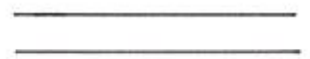
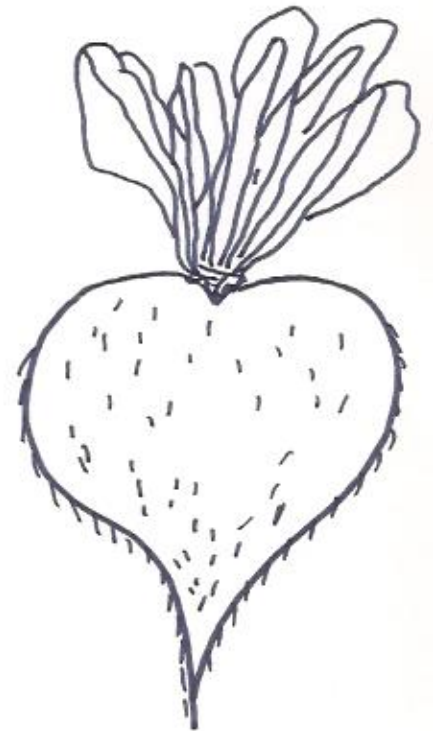
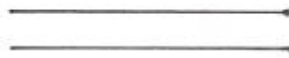
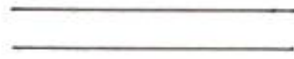
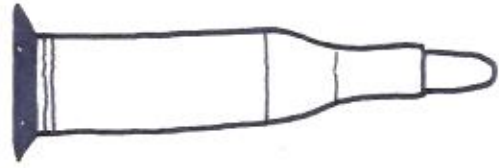
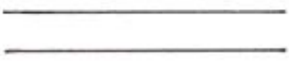
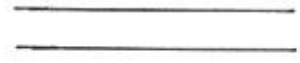
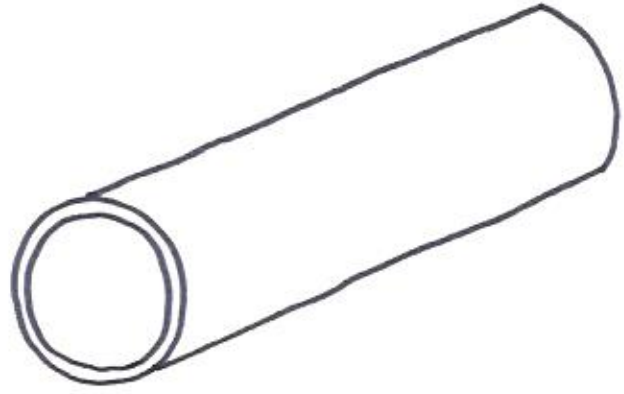
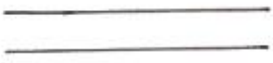

boa olla lleno bata
fabada tallo batido silla

b

ll

dictado

lla	lle	lli	llo	llu
-----	-----	-----	-----	-----

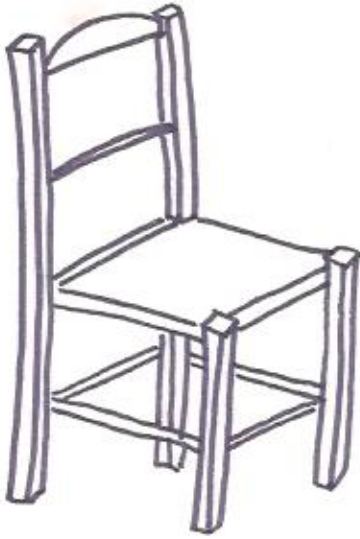

botella

olla

silla

pollito

llama

molinillo

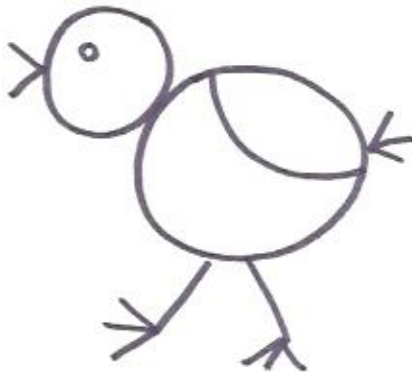



sill_

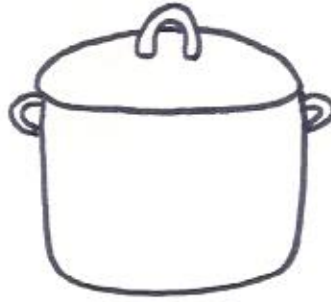

oll_



botell_



molinill_

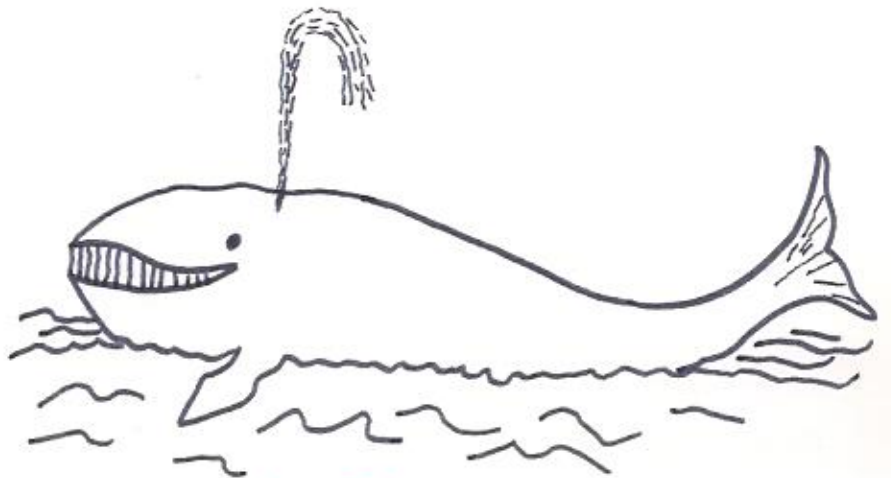

ball_na



sell_

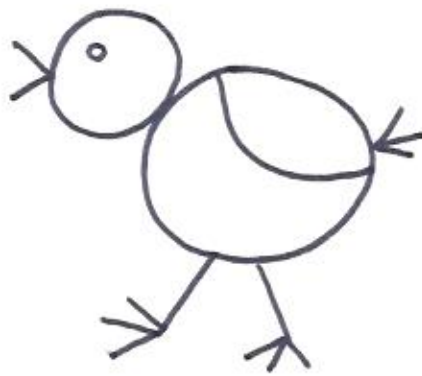

poll_to



ll_ma









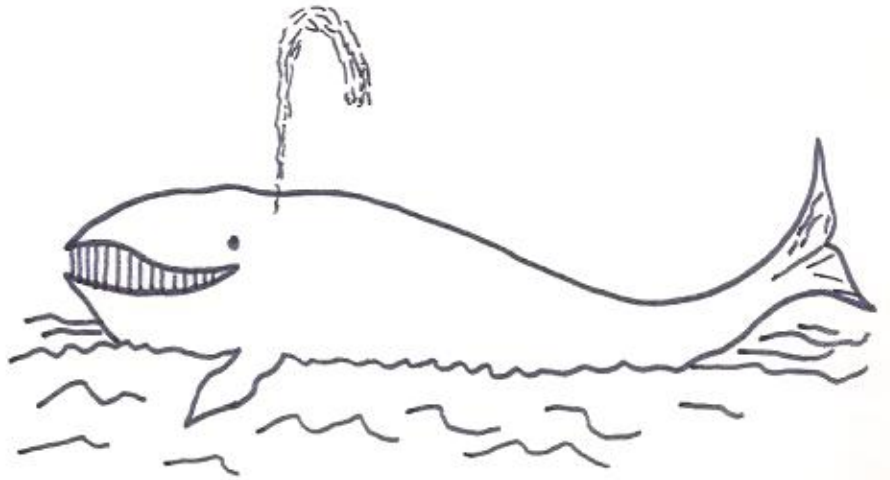



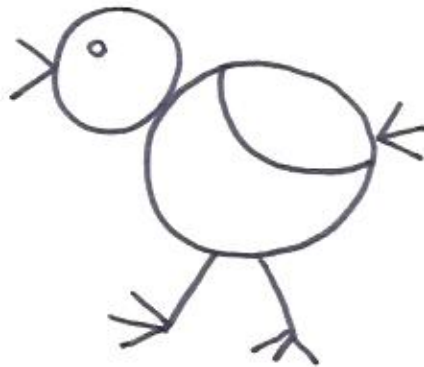



ballena pavo vaso vino
anillo toalla vida bellota

ll

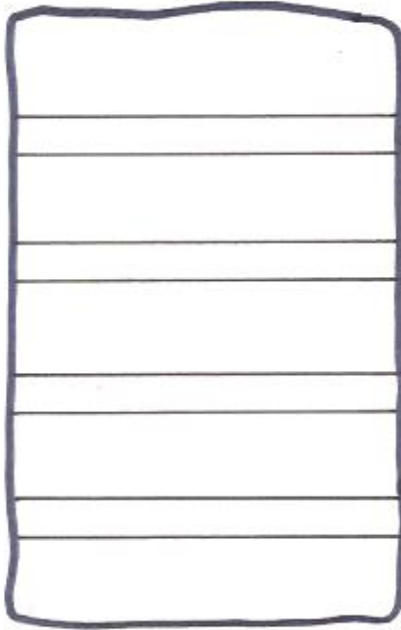

v

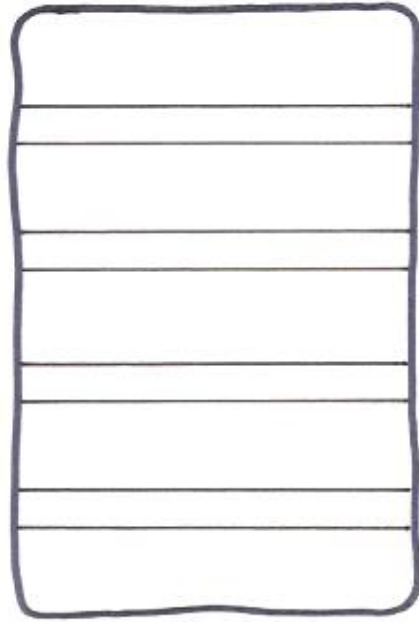

dictado

va	ve	vi	vo	vu
----	----	----	----	----

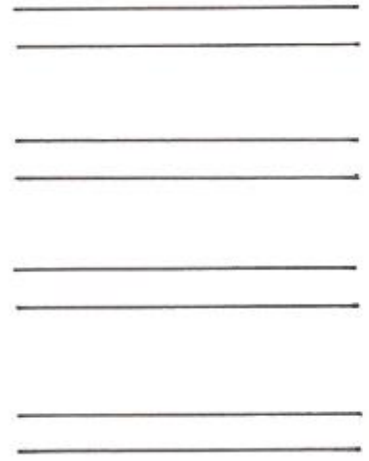
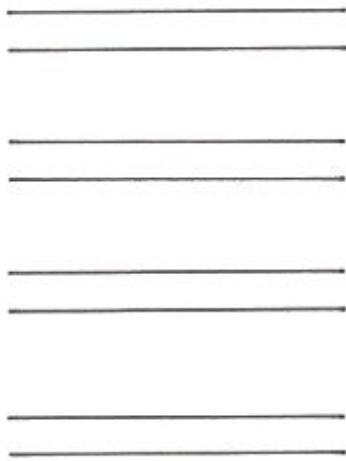
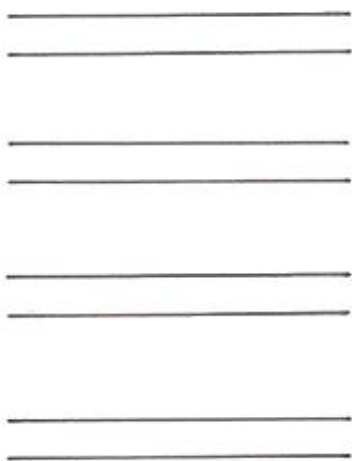



vaso

vela

llave

lluvia

vino

avioneta

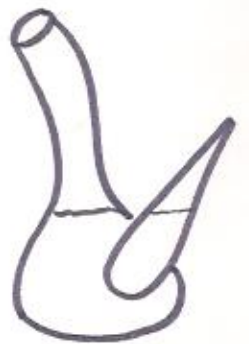
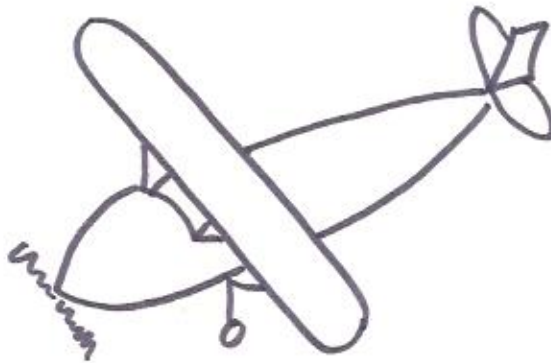

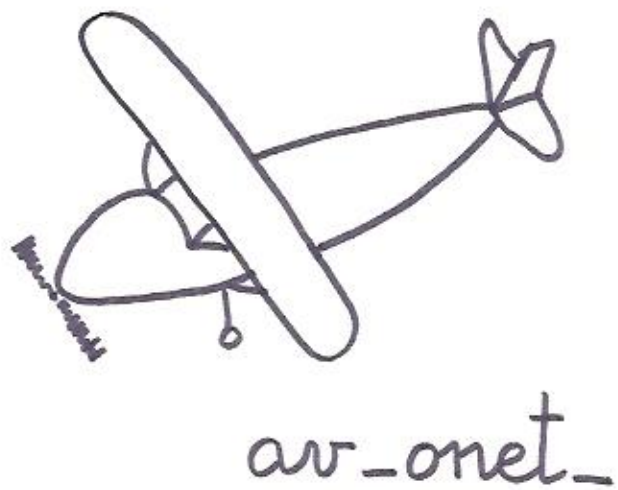
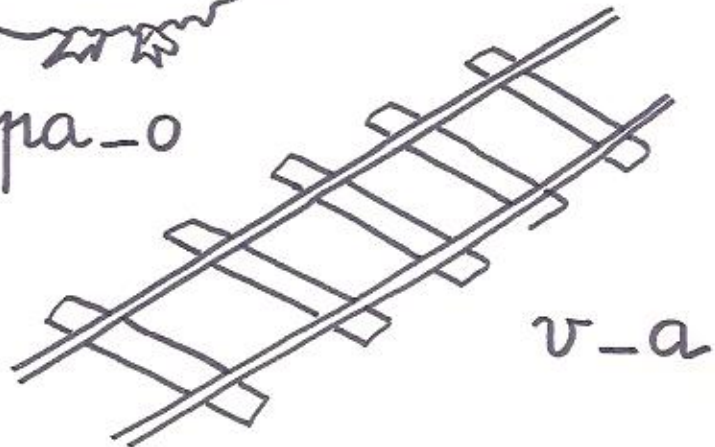
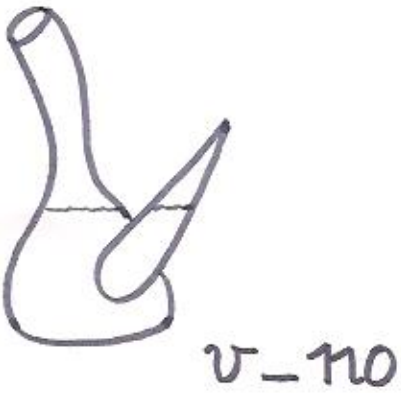
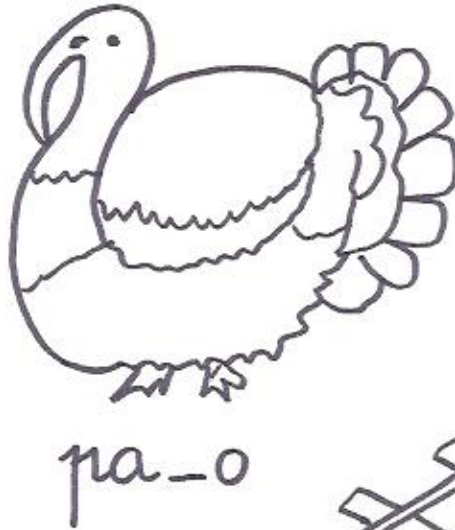









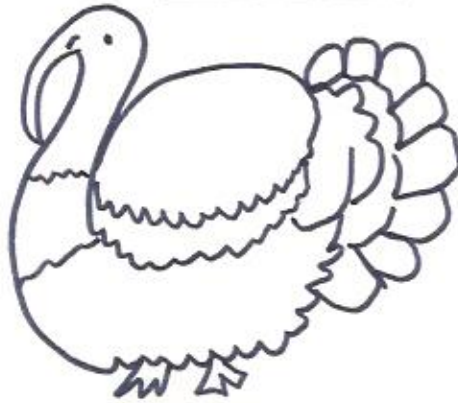



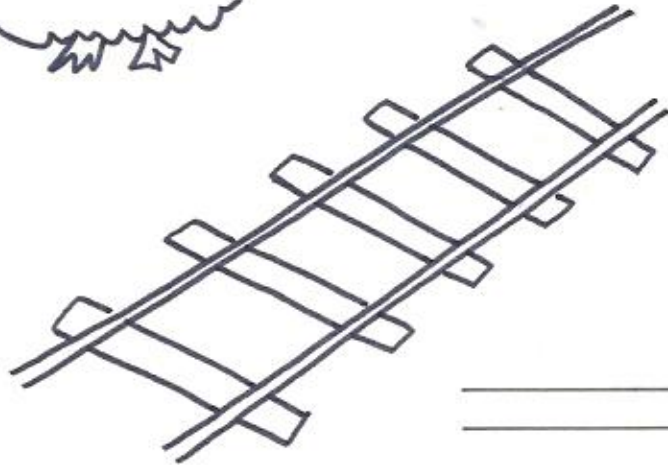



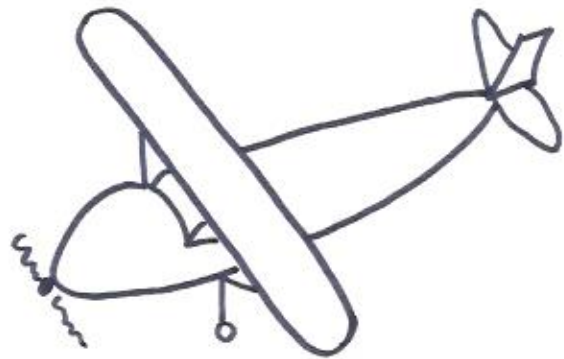

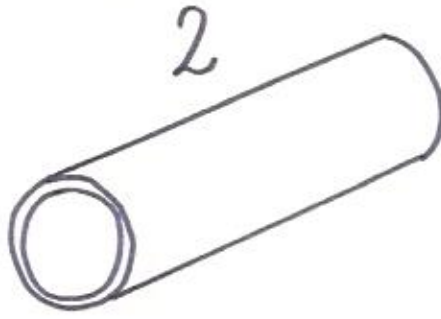

autodictado

1. _____

4. _____

7. _____

2. _____

5. _____

8. _____

3. _____

6. _____

9. _____

visita camisa cuello vela
oliva café vaso colonia

v

c

dictado

ca		co		cu
----	--	----	--	----



cuna

cubo

casa

caballo

foca

pico

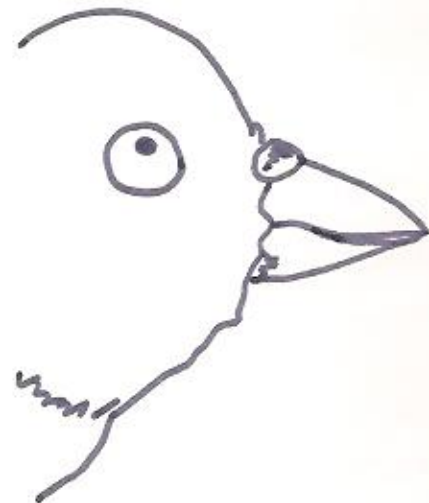
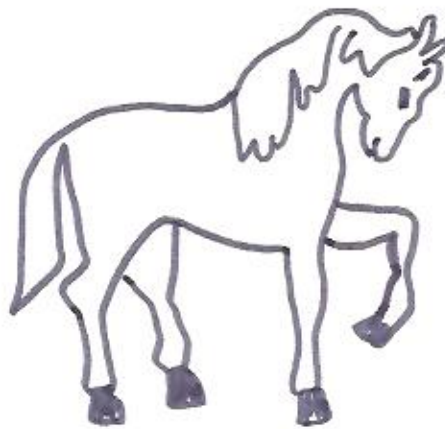
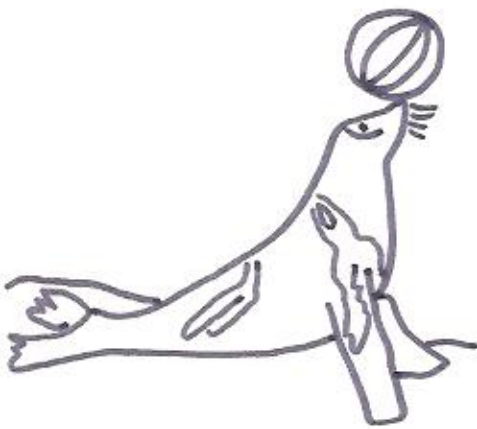



casa



cuna



picota



cubo



come



cama

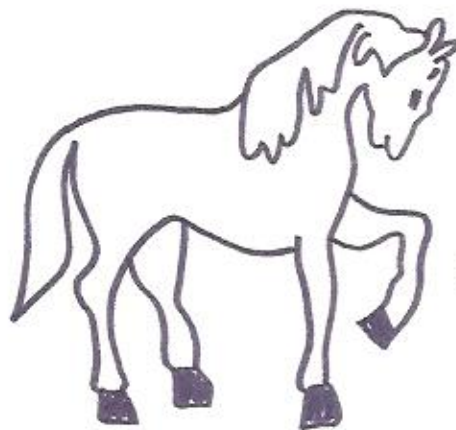

caballo



foca

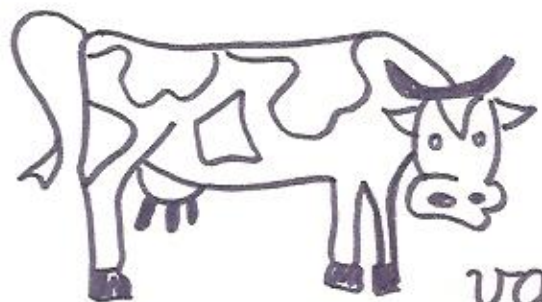

vacuna

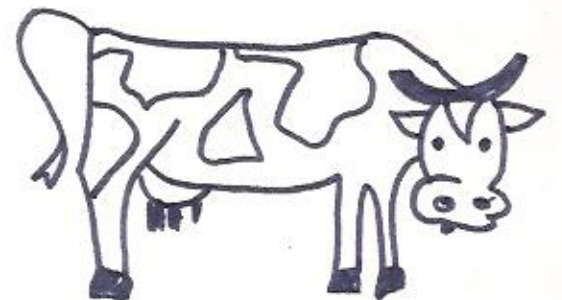
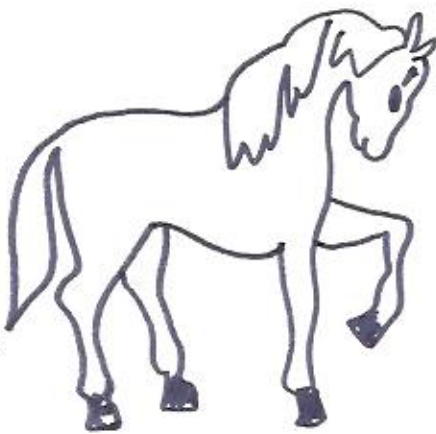
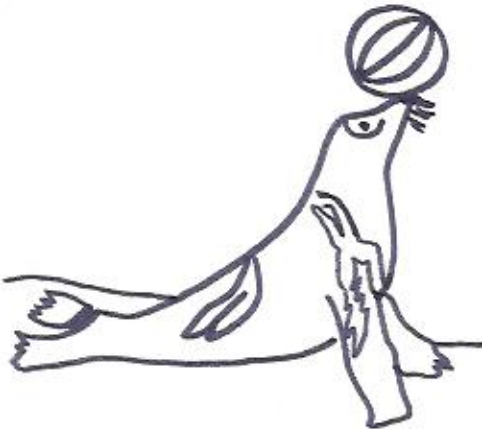
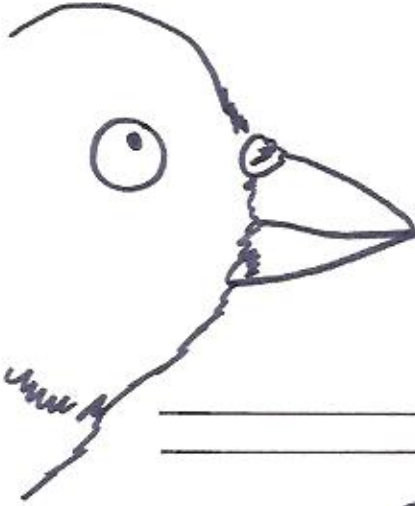
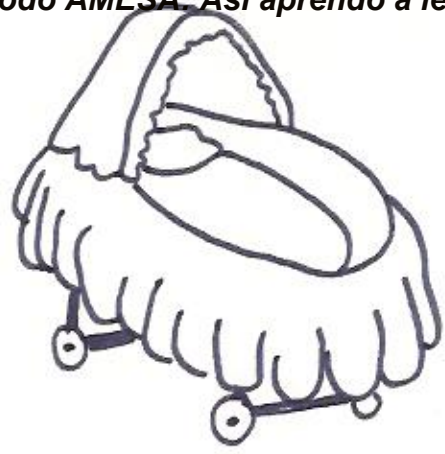

ocho bicho carna leche
foca chato cubo calle

↓
c

↓
ch

dictado

cha	che	chi	cho	chu
-----	-----	-----	-----	-----

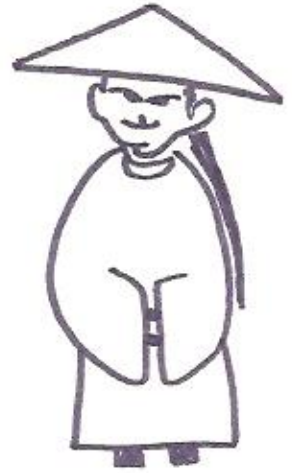
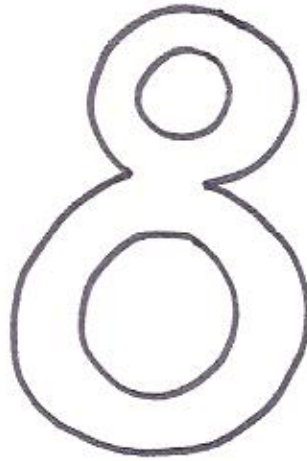
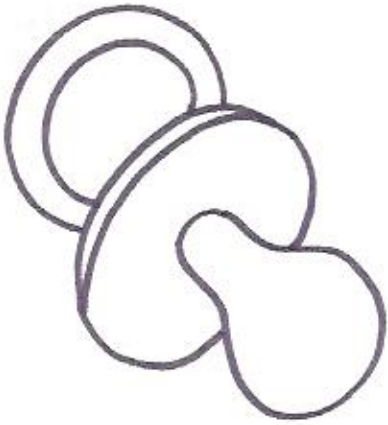

chino

ocho

chupete

chucho

leche

fecha

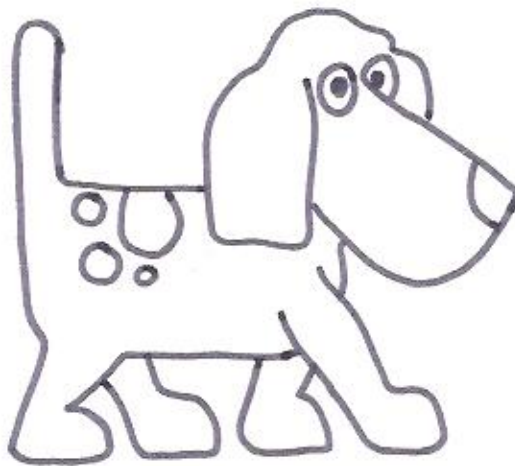

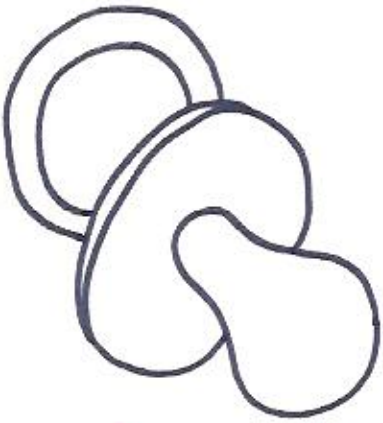

ch_pete

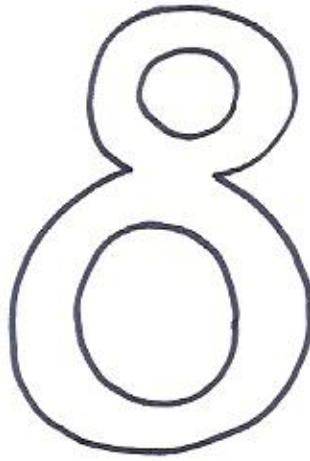

och_



ch_no



lech_

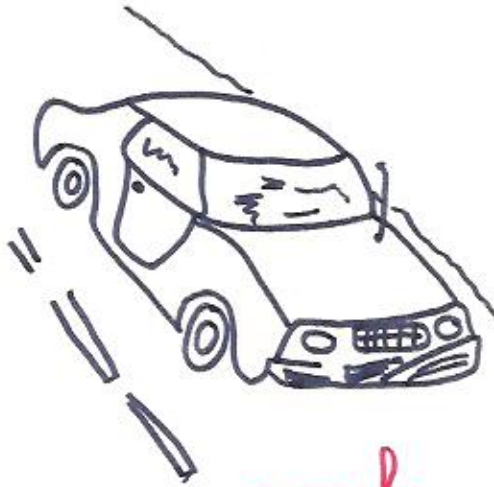

coch_

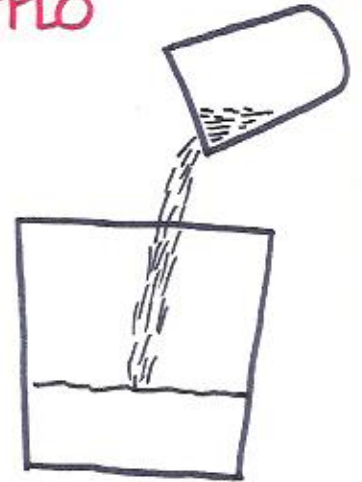

ech_

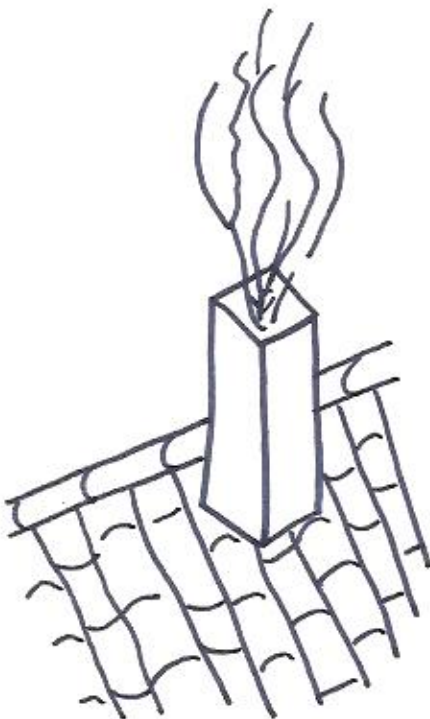

ch_menea



fech_



ch_ch_

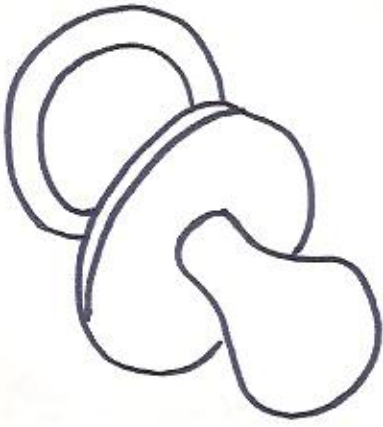

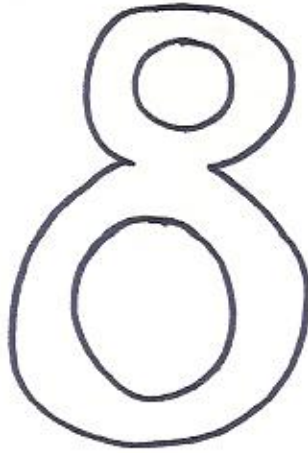







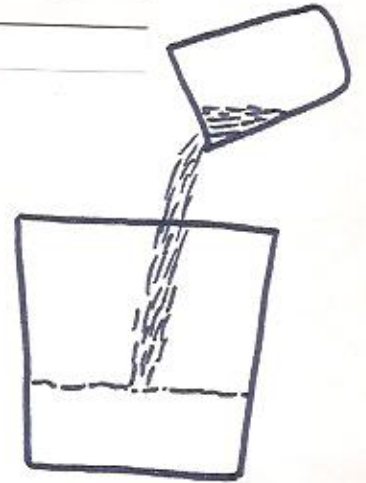

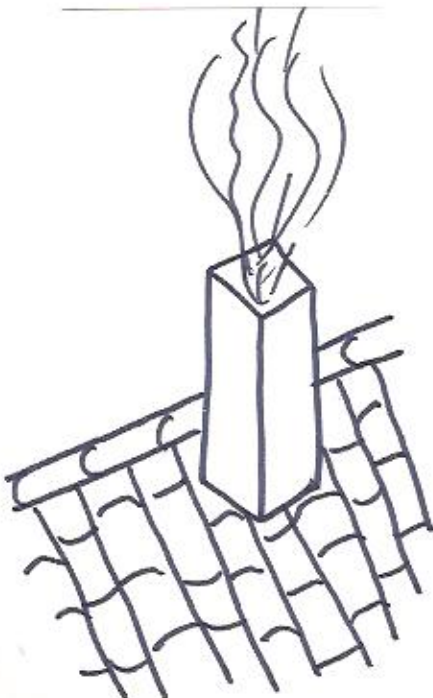





maño chivo sueño chucho
baño mañana coche fecha

↓
ch

↓
ñ

dictado

ña	ñe	ñi	ño	ñu
----	----	----	----	----

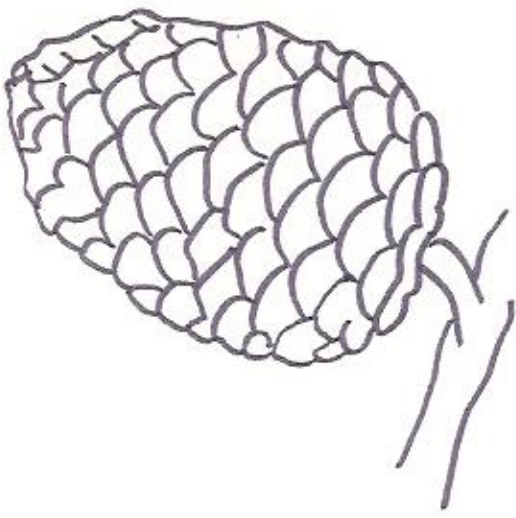

caña



piña



muñeca



niña

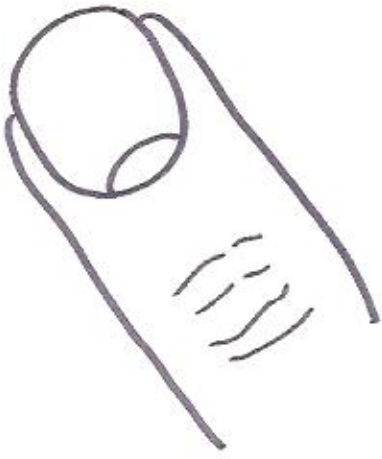

и̃-и̃-

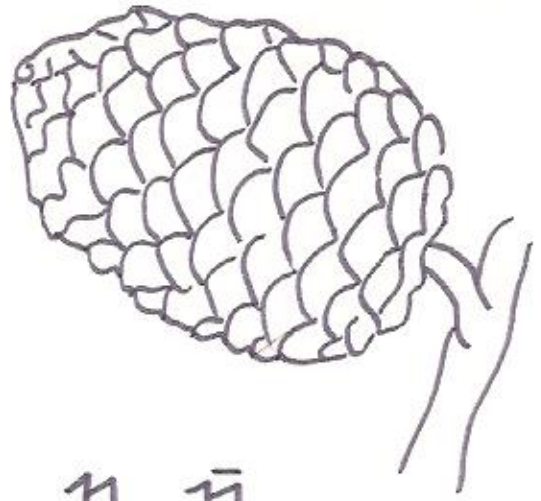

р-и̃-



са̃-и̃-



мо̃-и̃-



н-и̃-

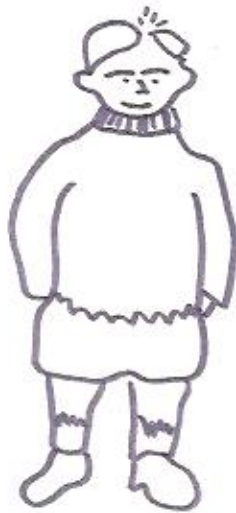

н-и̃-



ми̃-са

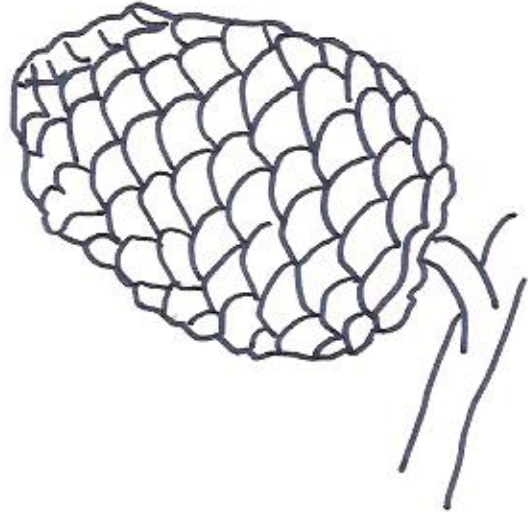

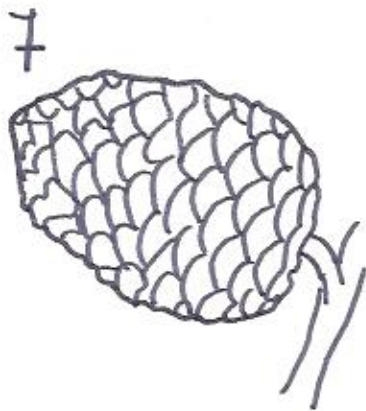

autodictado

1- _____

4- _____

7- _____

2- _____

5- _____

8- _____

3- _____

6- _____

9- _____

rueda radio paño risa
rubio niño uña leña

↓
r̄

↓
r̄

dictado

ra	re	ri	ro	ru
----	----	----	----	----



rabo



rana



rosa

rama

rio

rata

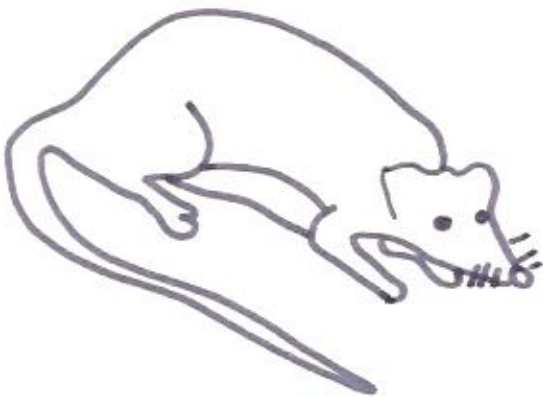



r-na

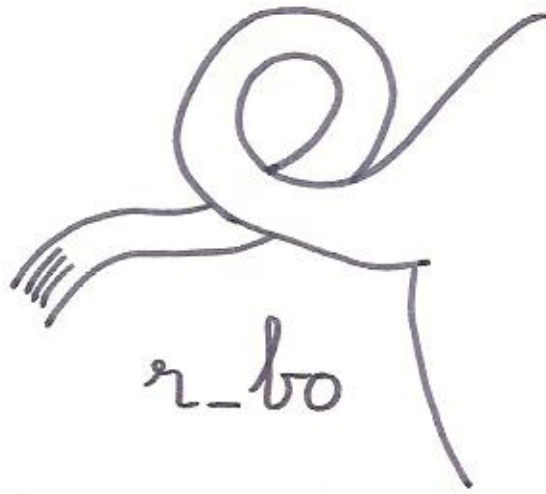

r-bo

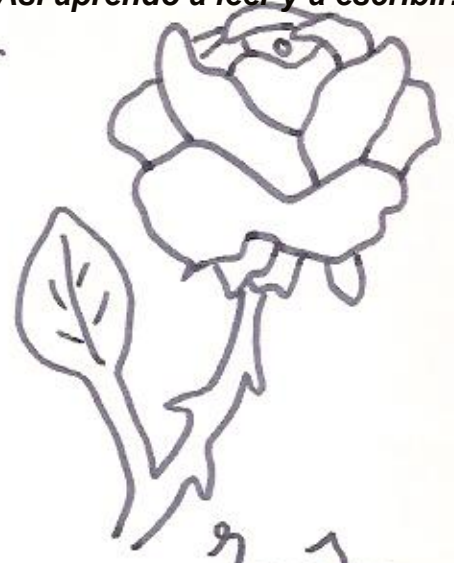

r-s-

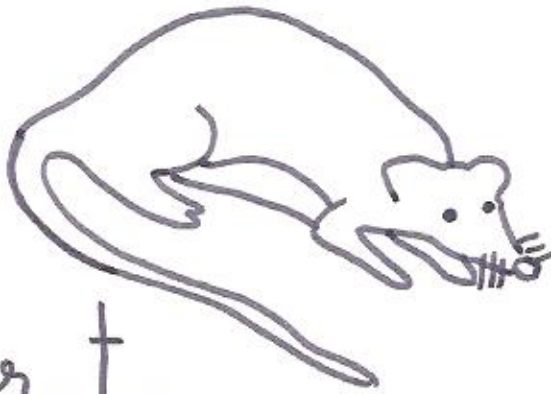

r-t-



r-na



r-o

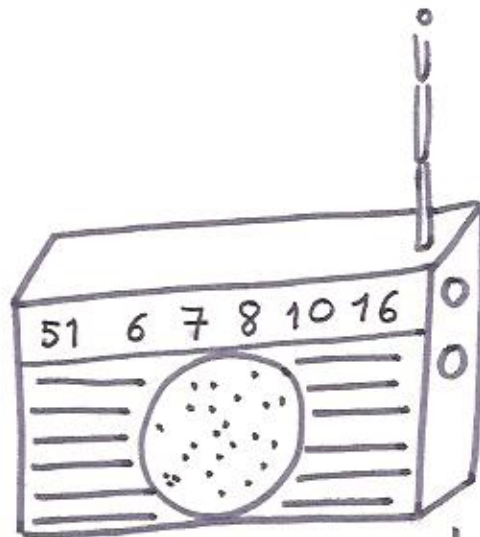

r-dio

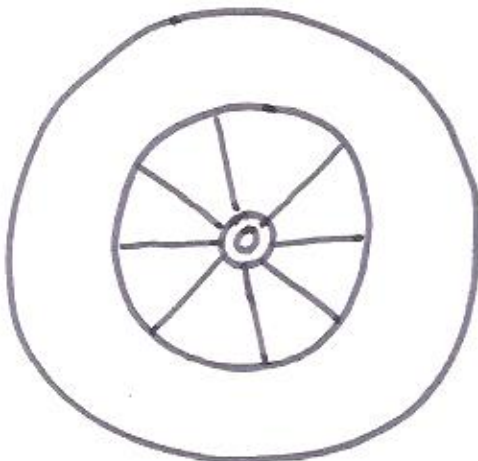

r-eda



==



==



==



==

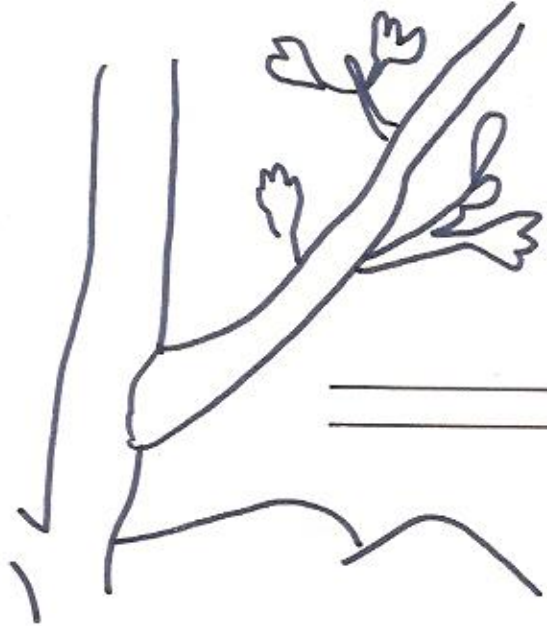

==

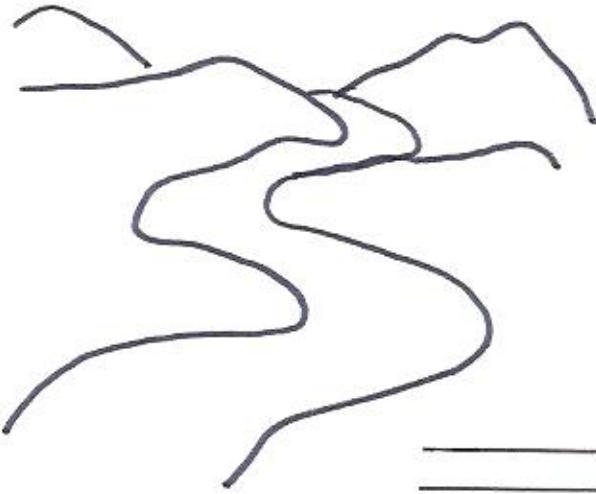

==

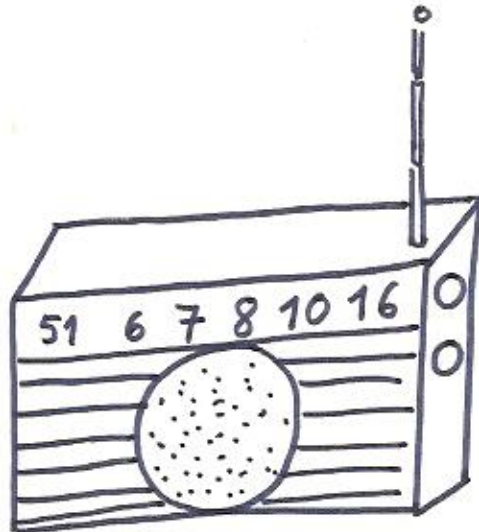

==

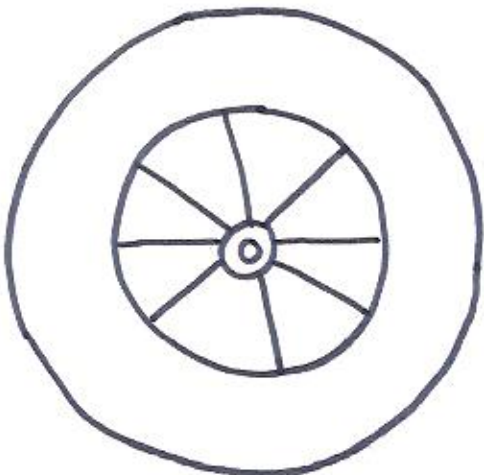

==

barro rosa torre sierra
rama carrito ruso ropa

↓
r

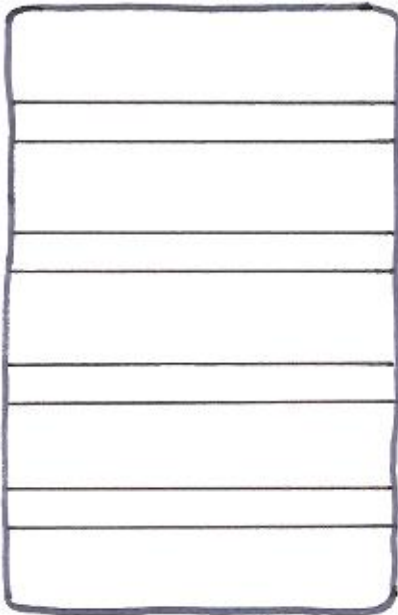

↓
rr

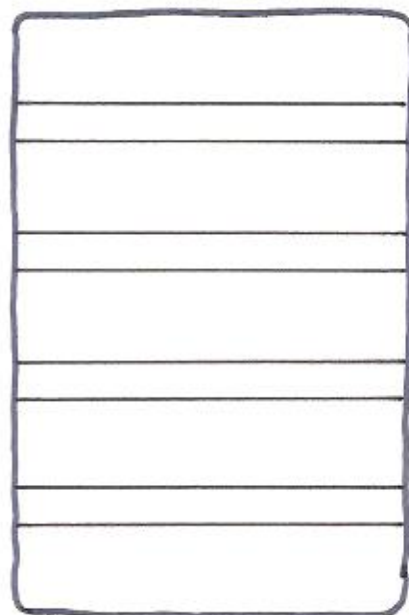

dictado

rra	rre	rri	rro	rru
-----	-----	-----	-----	-----

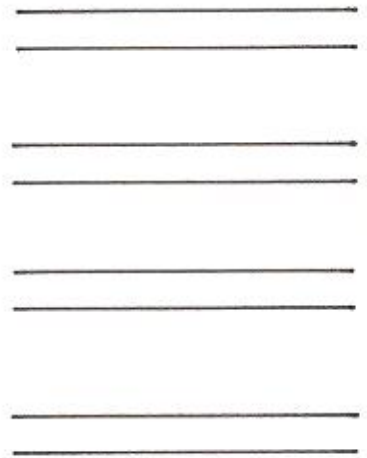
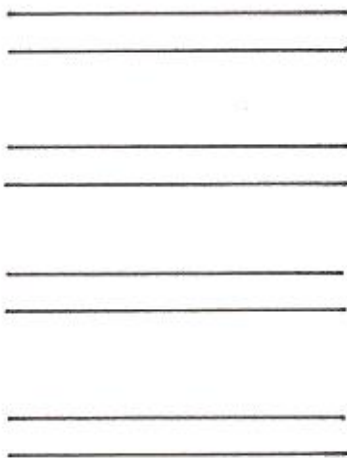
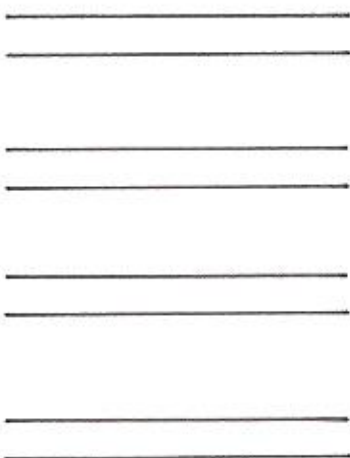

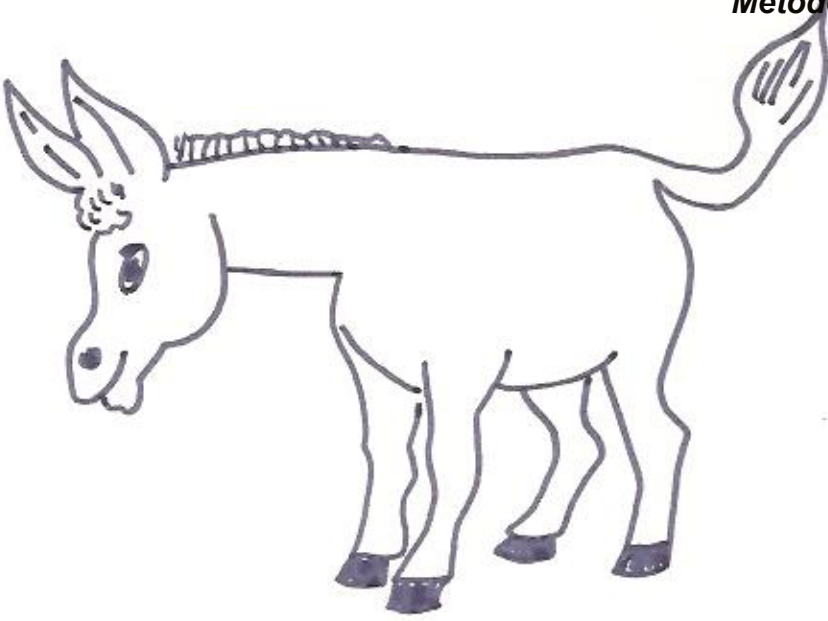

serrucho

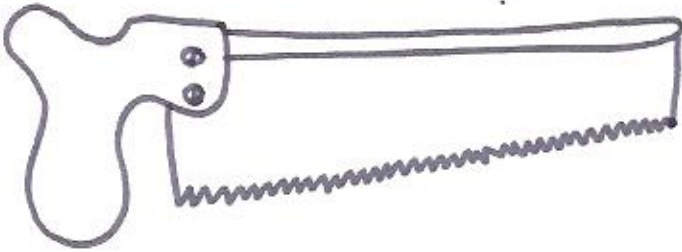

burro

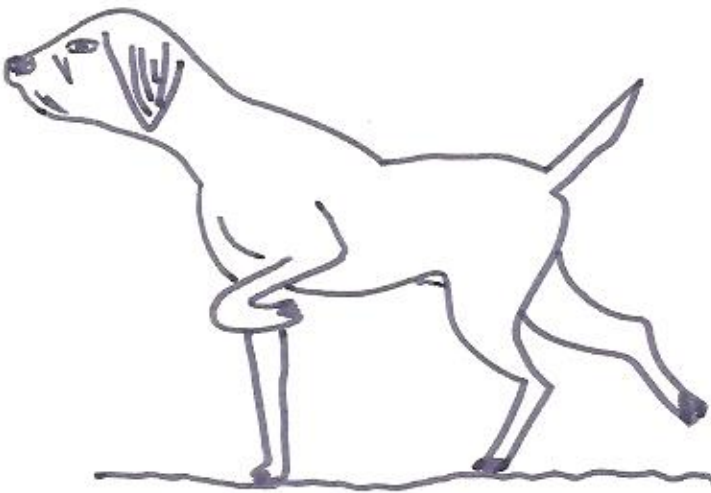

torre

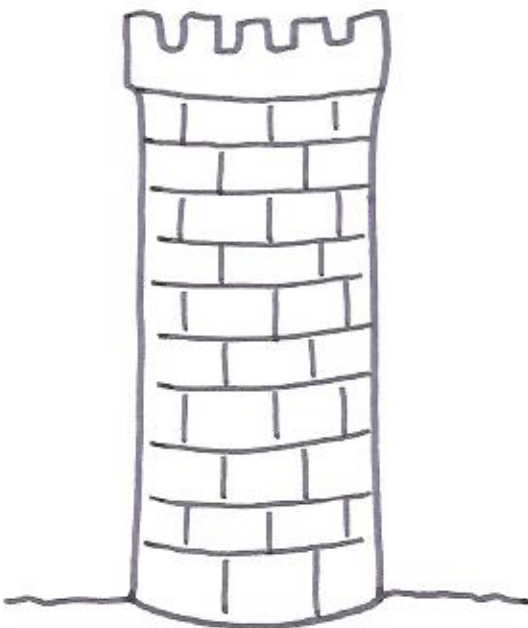

perro

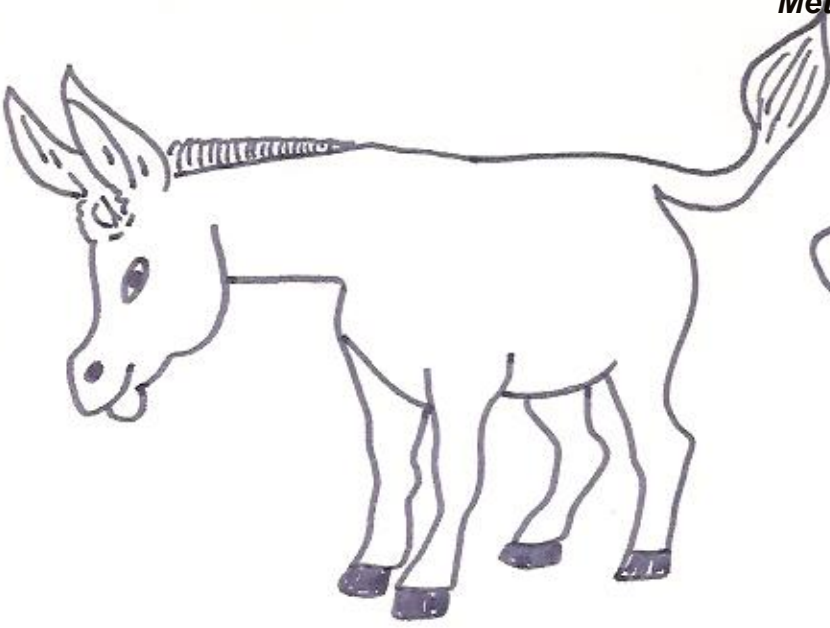

b-rr-

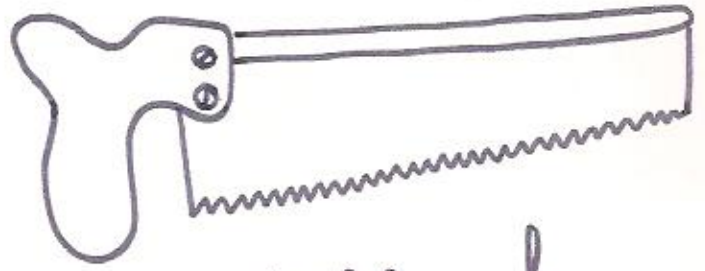

serr-cho



chorr-

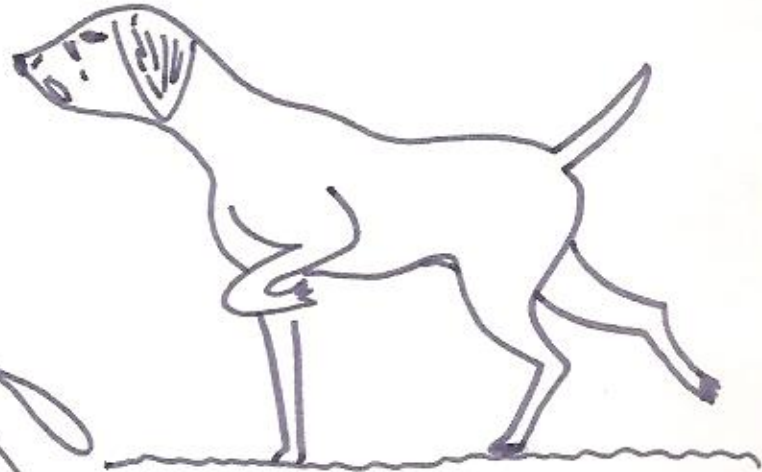

p-rr-

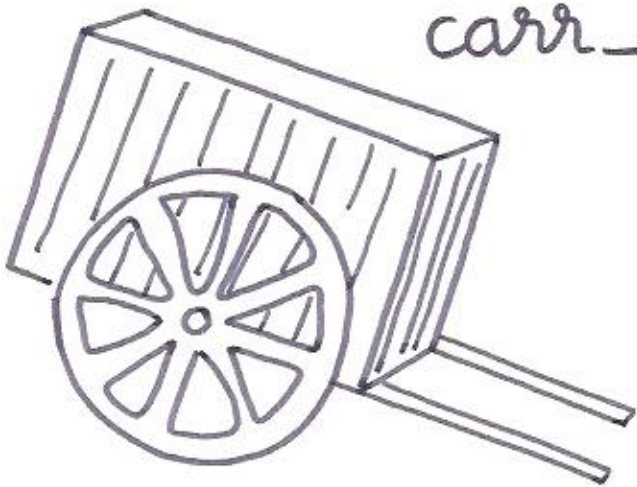

carr-

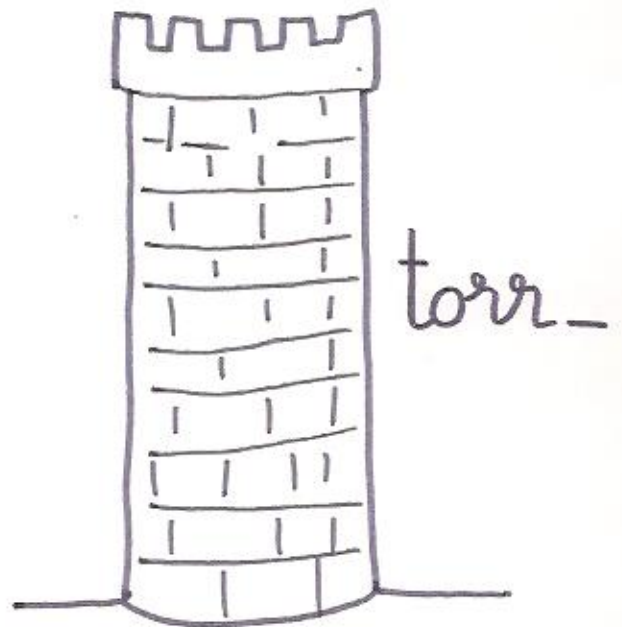

torr-

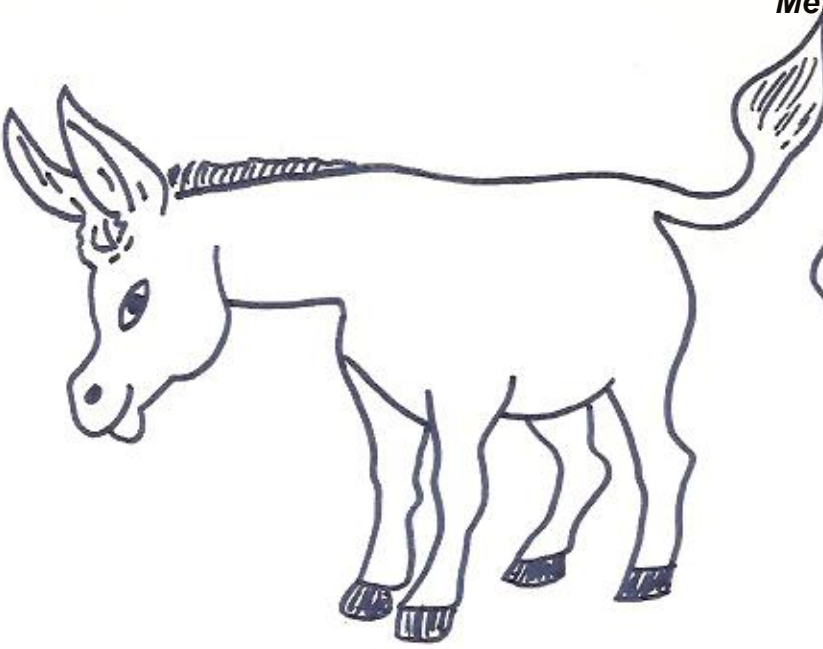

==

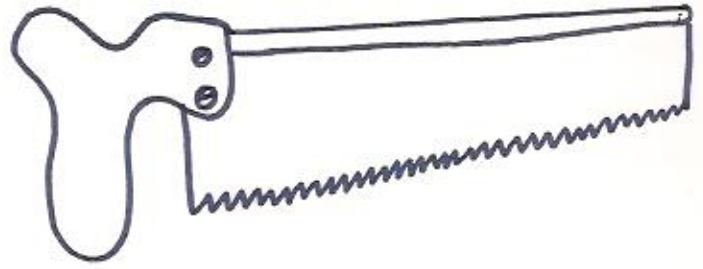

==



==

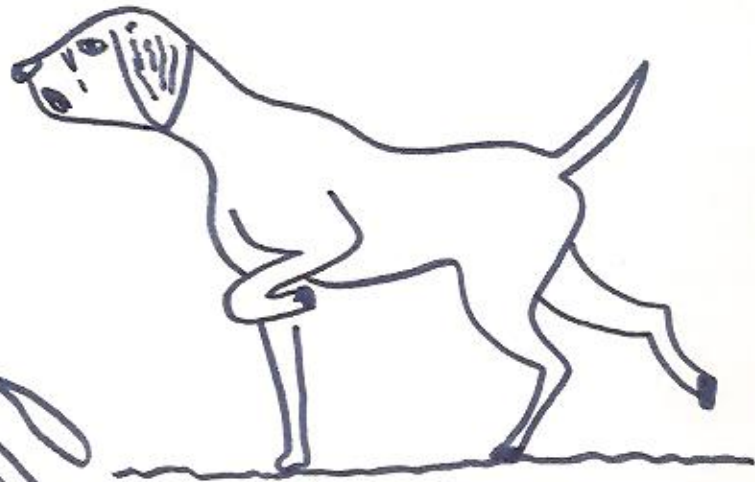

==

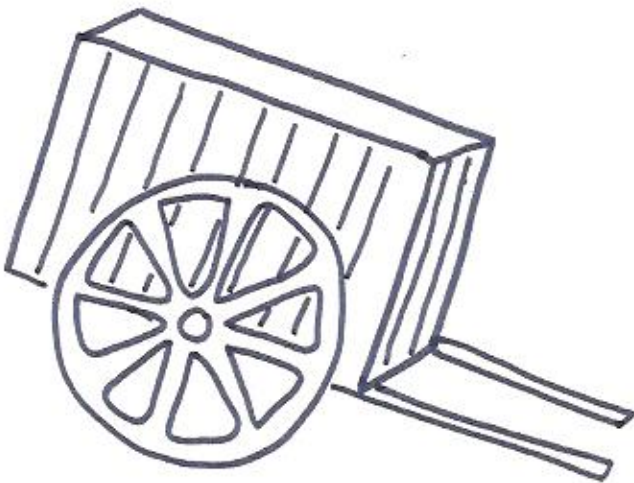

==

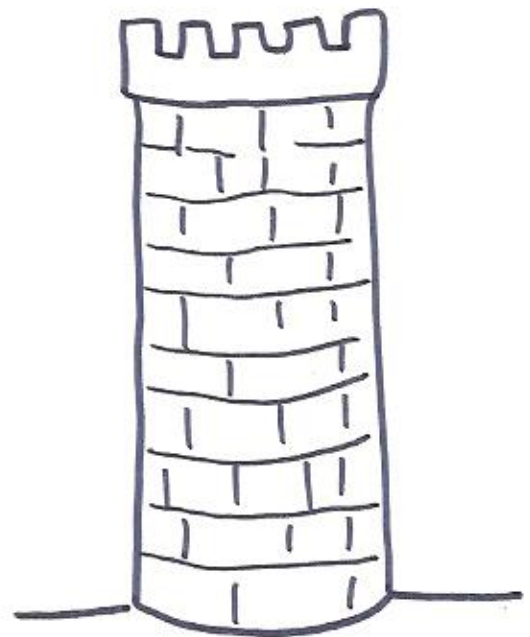

==

vara parra burro toro
corro cara faro perro

rr

rr

dictado

re	ra	ri	ro	ru
----	----	----	----	----

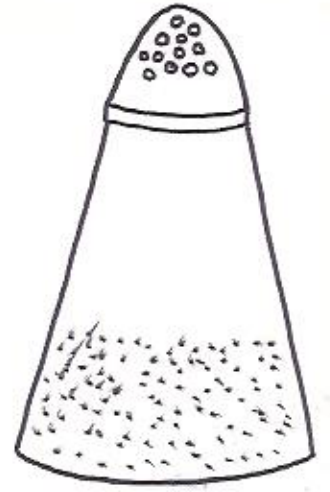
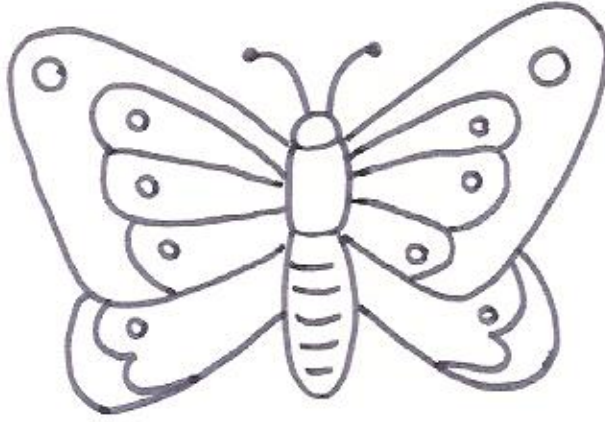
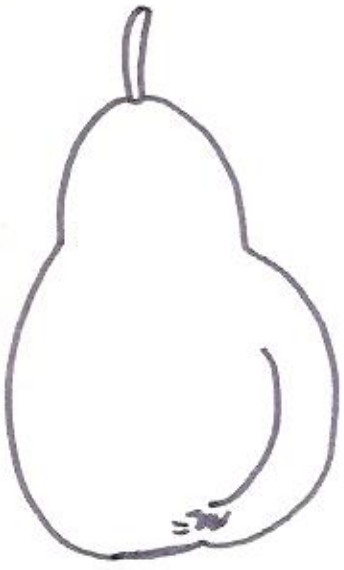

mariposa

puro

pera

salero

caramelo

araña

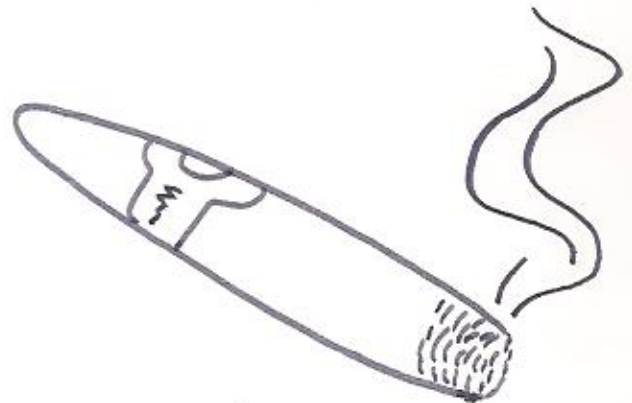
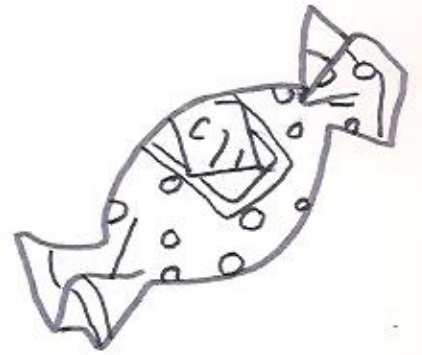
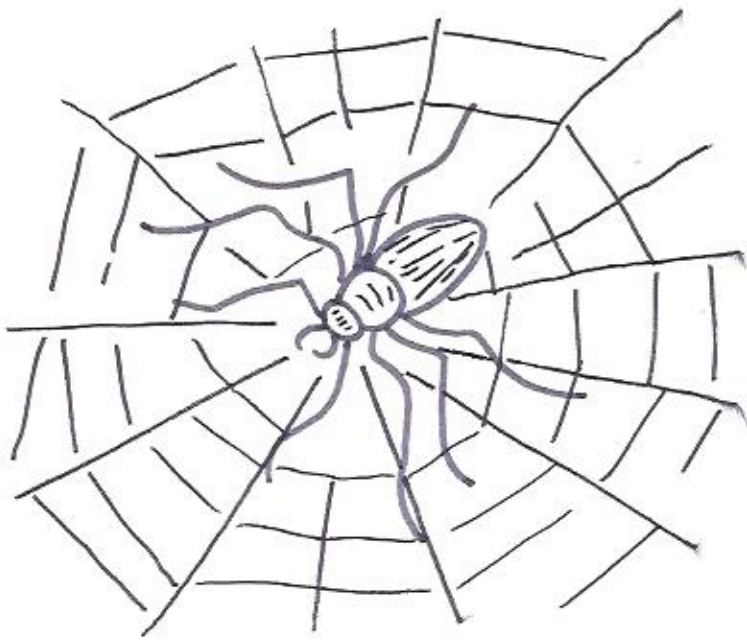

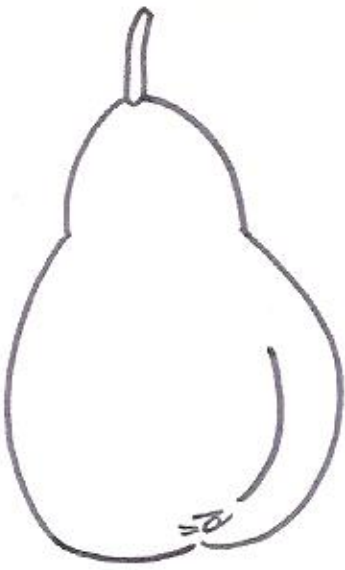

per_

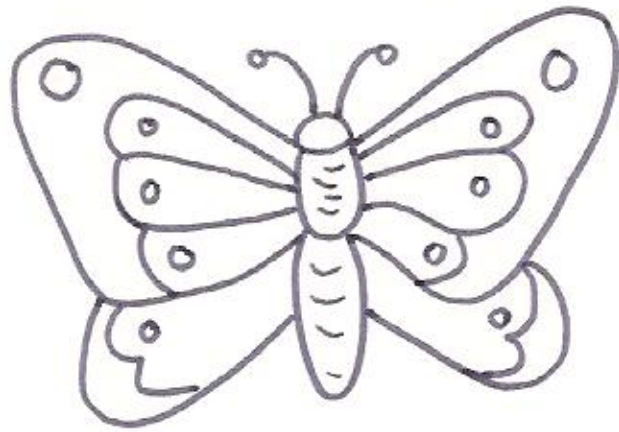

mar_posa

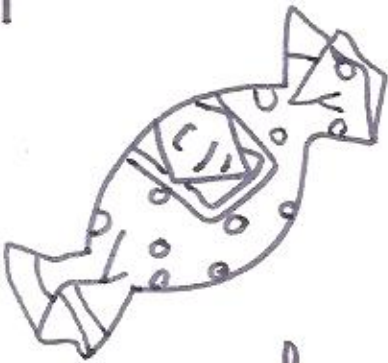

car_mel_

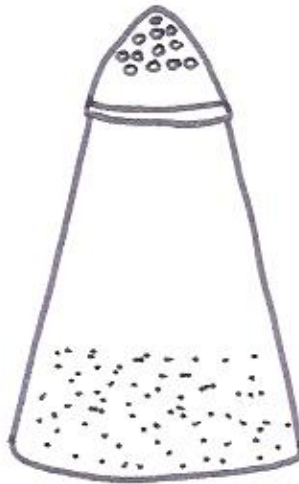

saler_

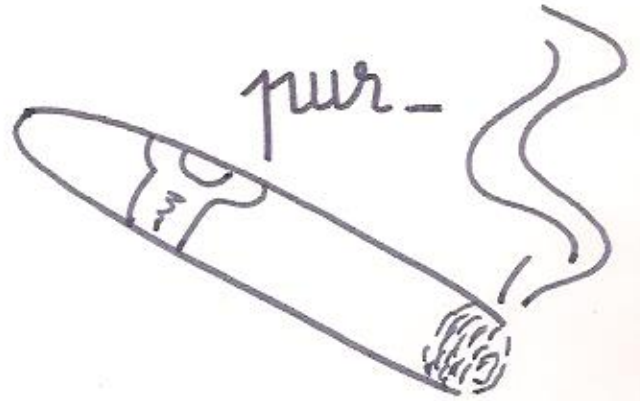

pur_

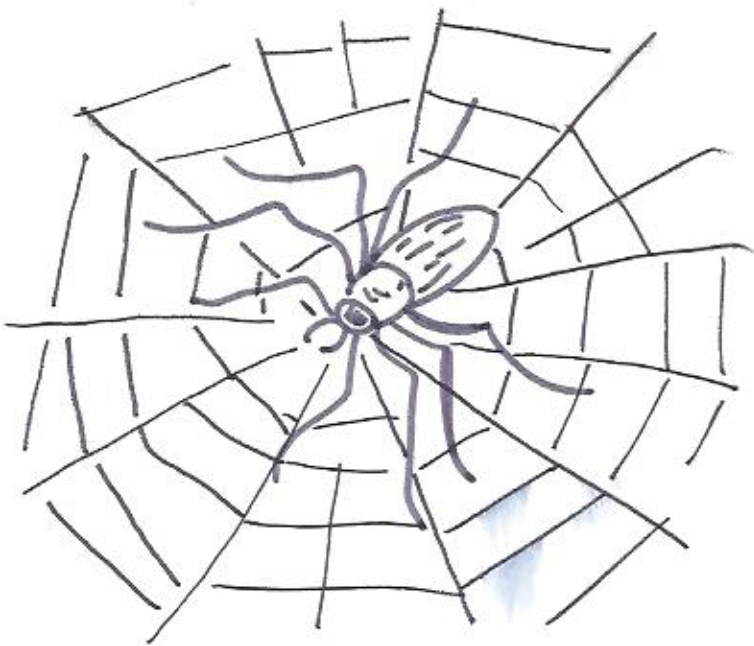

ar_ñ_

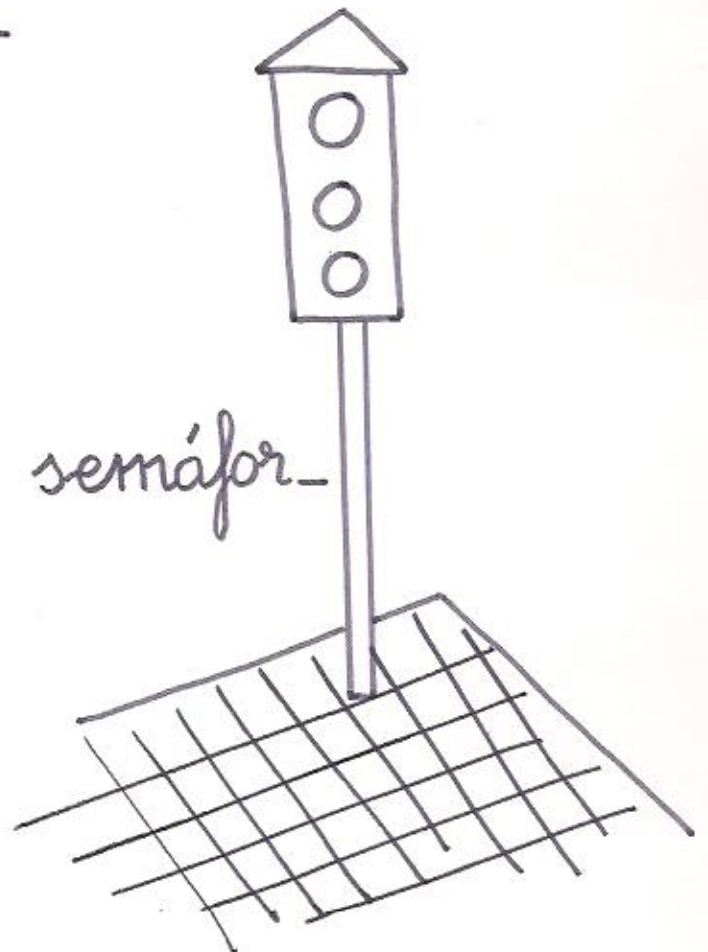

semáfor_

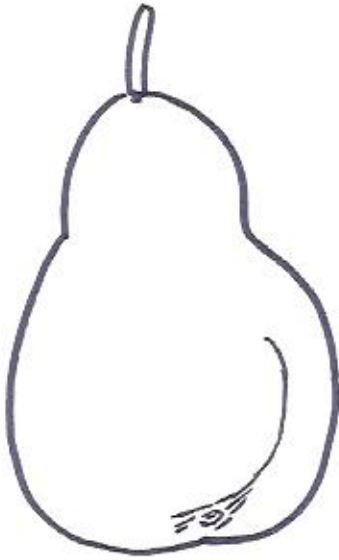

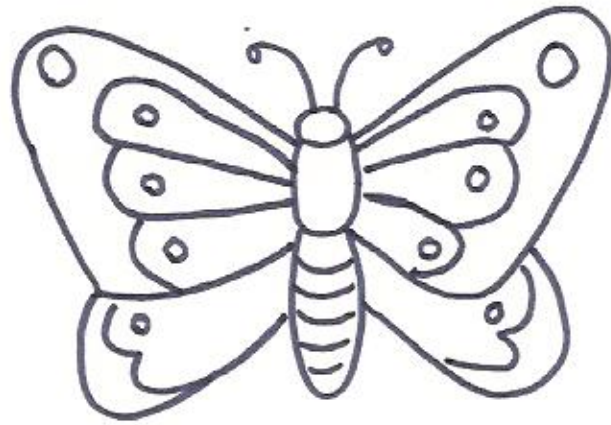



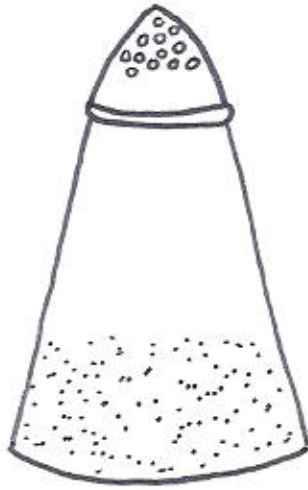

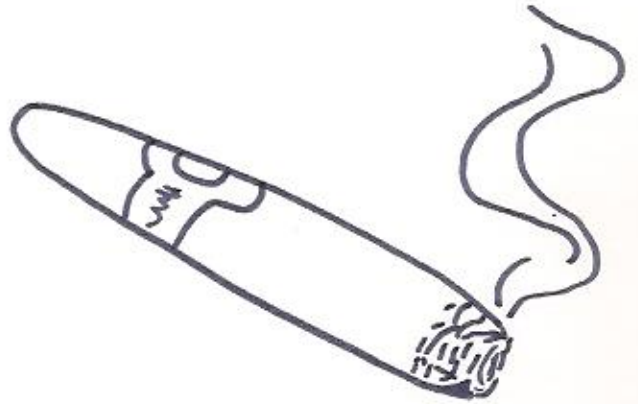

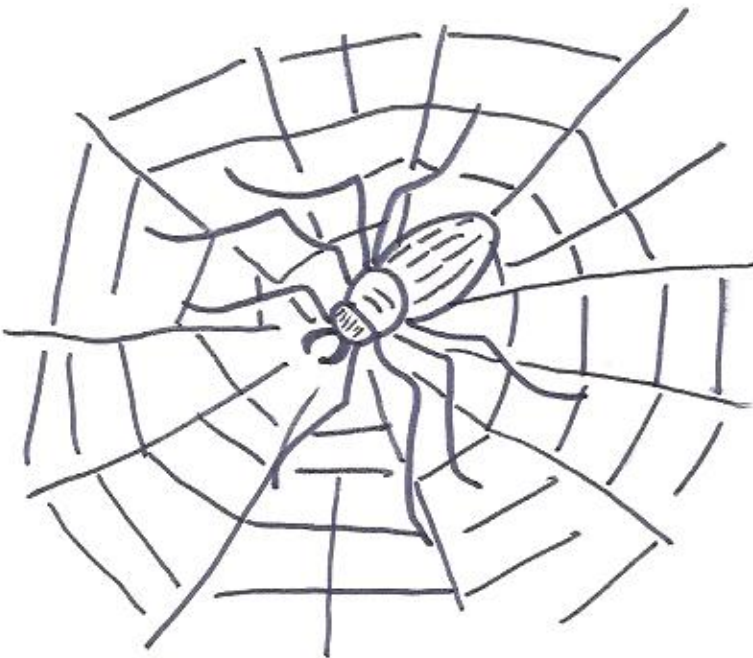

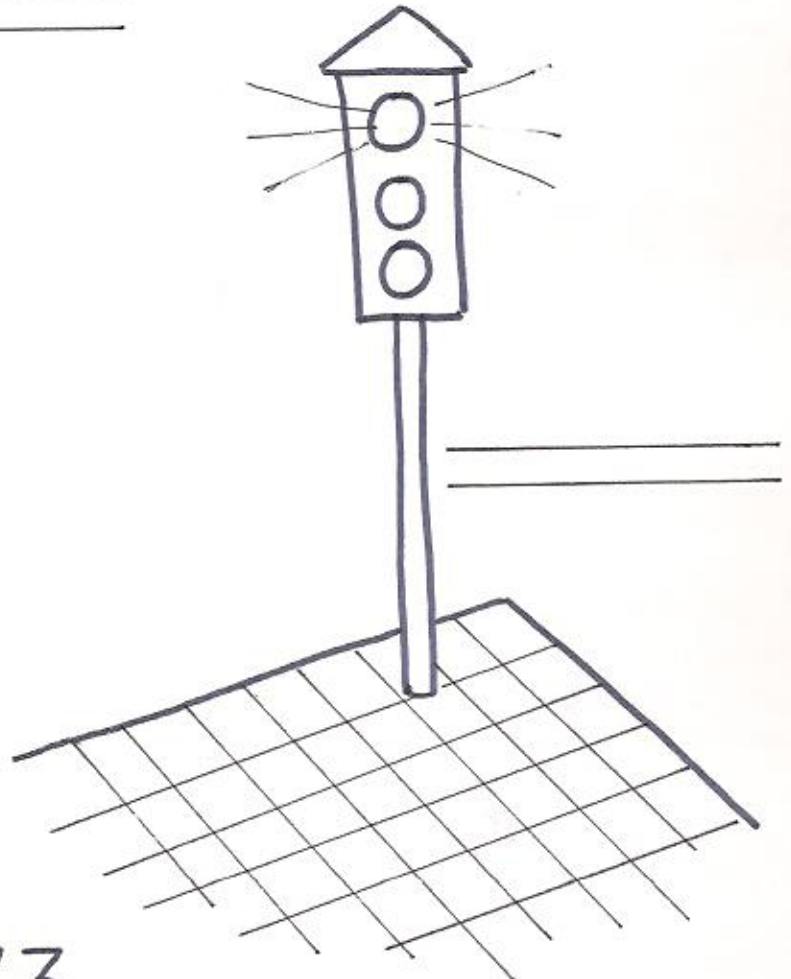

1

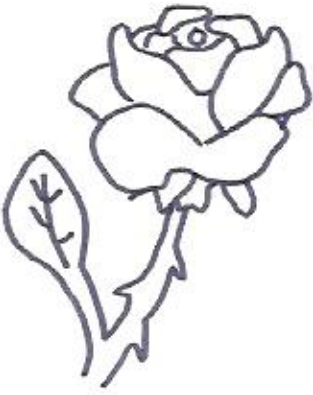

2



3



4

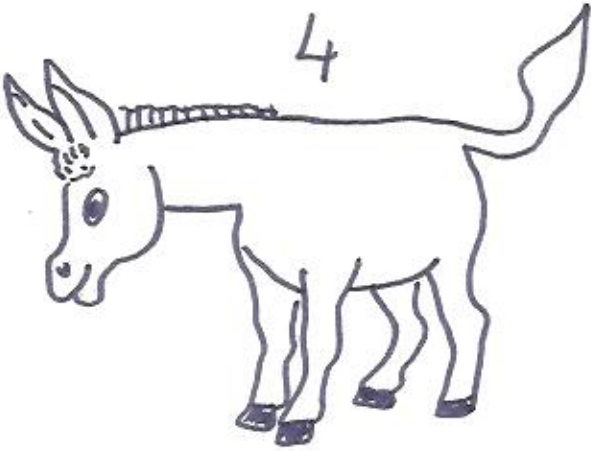

5

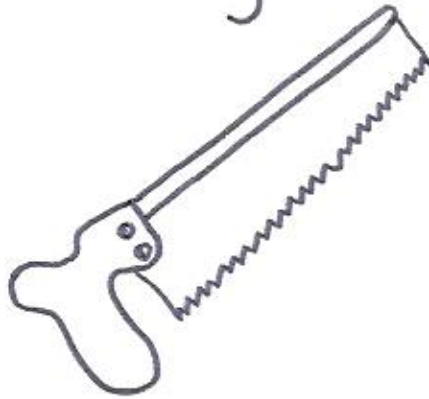

6

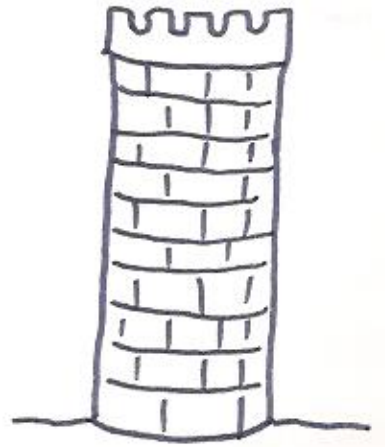

7

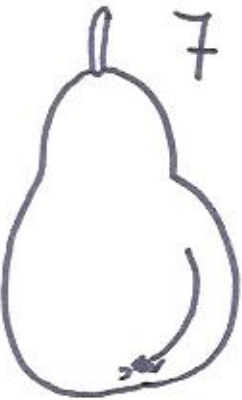

8



9

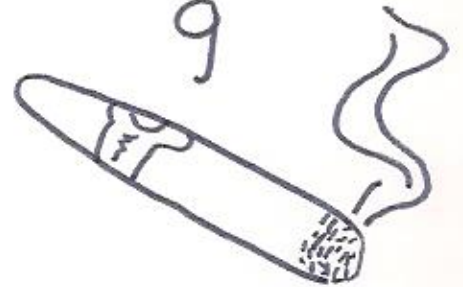

autodictado

1- _____

4- _____

7- _____

2- _____

5- _____

8- _____

3- _____

6- _____

9- _____

mariposa cine cielo araña
cepillo lorito salero cima

↓
r

↓
ce-ci

dictado

	ce		ci	
--	----	--	----	--

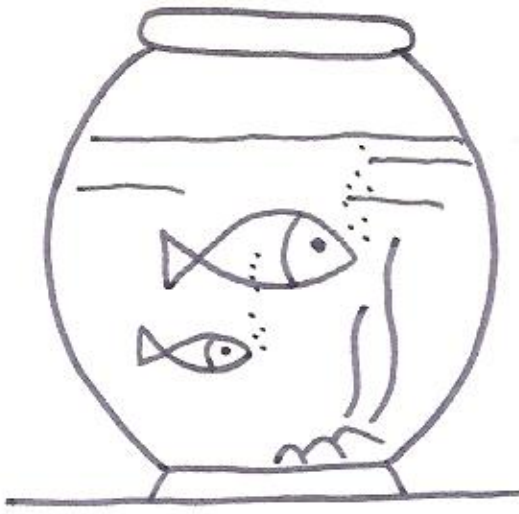

pec-ra

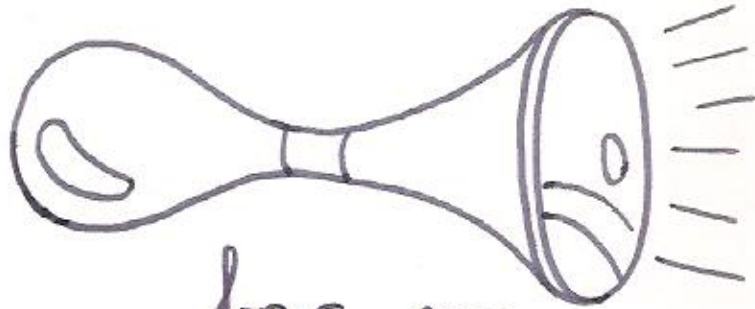

boc-na



mac-t-



lapic-ro

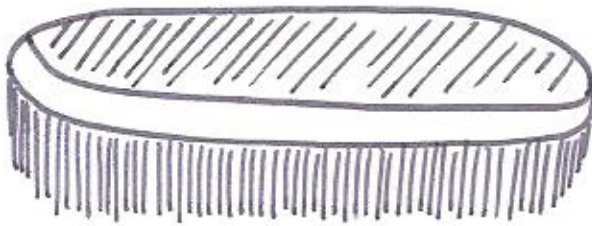

c-pill-

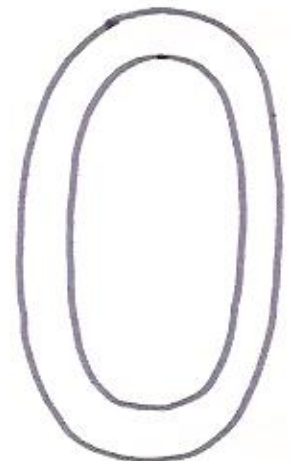

c-ro



c-rilla



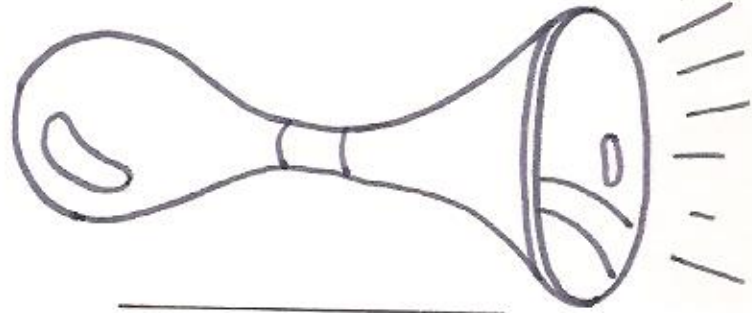



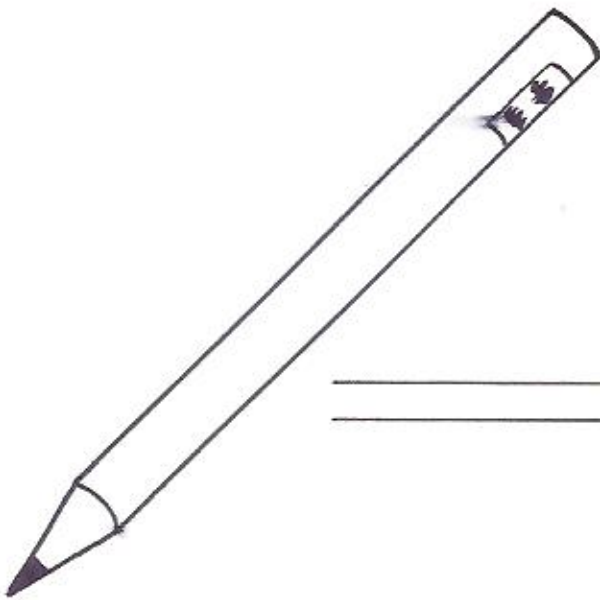

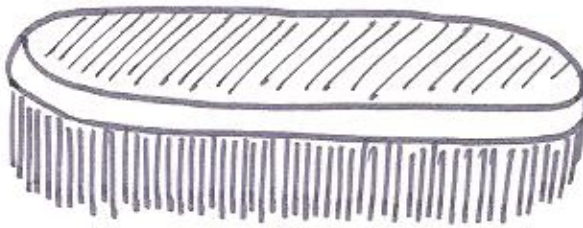

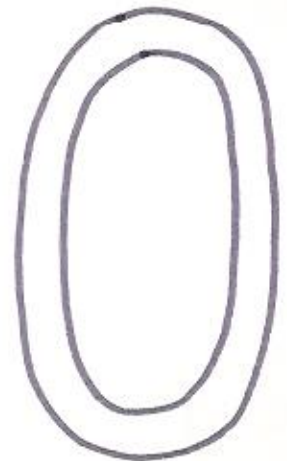



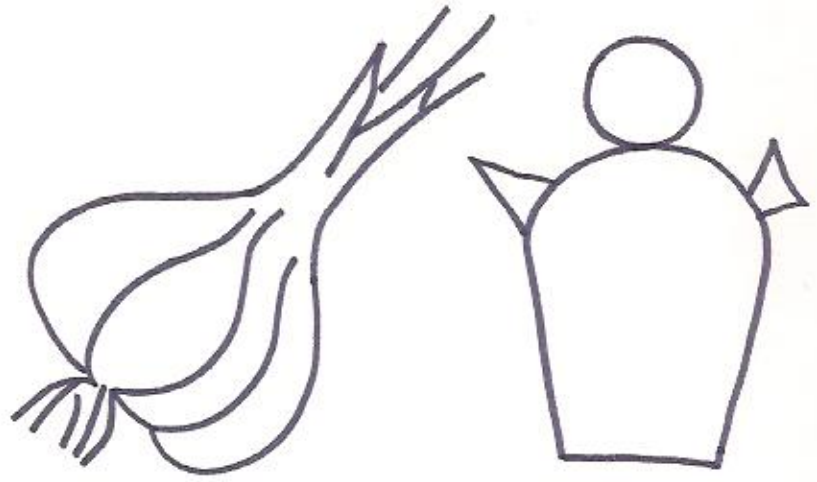

ajo

conejo

botijo

oveja

ojo

jaula

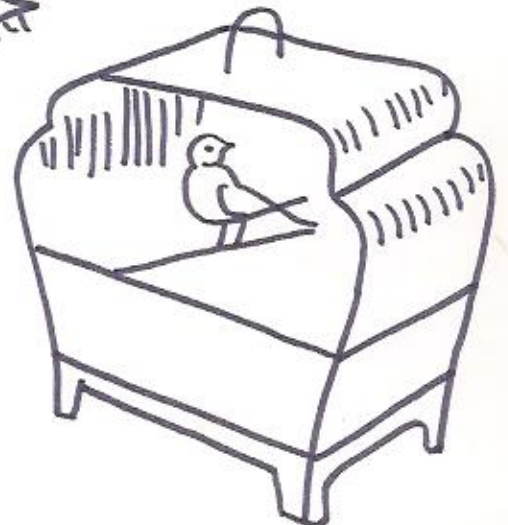
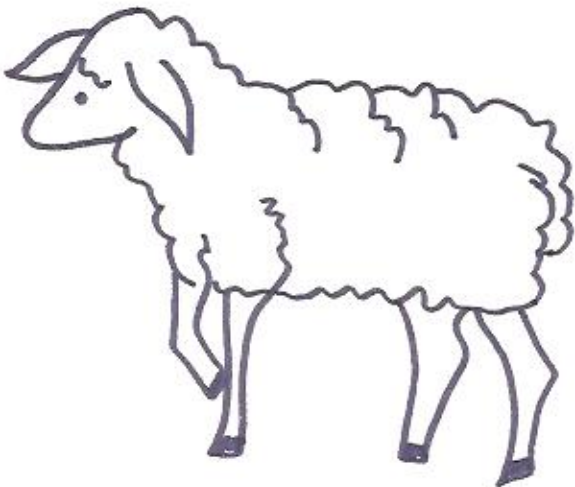



conej-

j-rafa

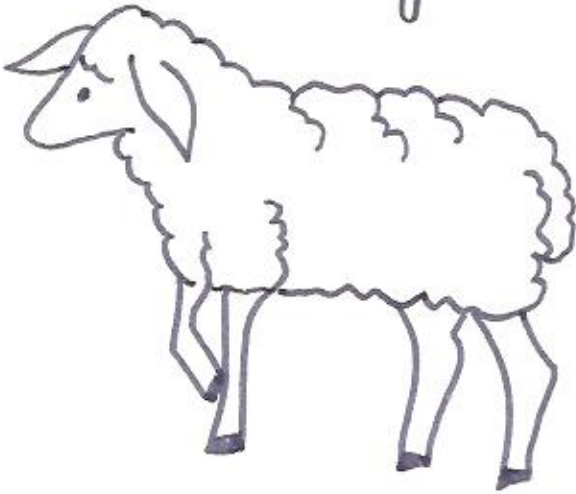

ovej-

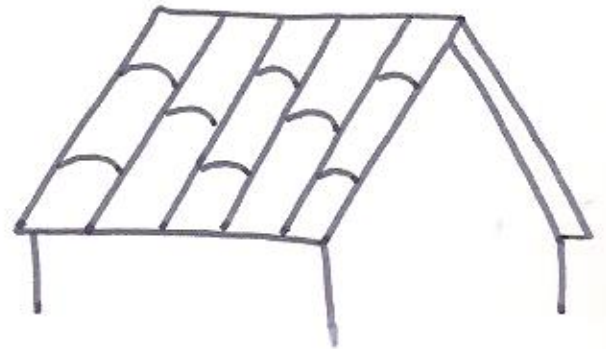

tej-do

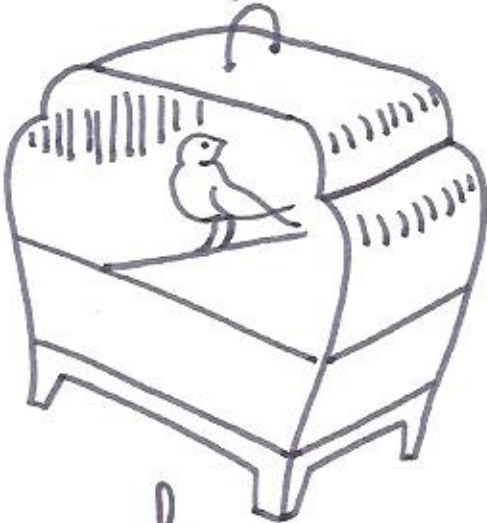

j-ula

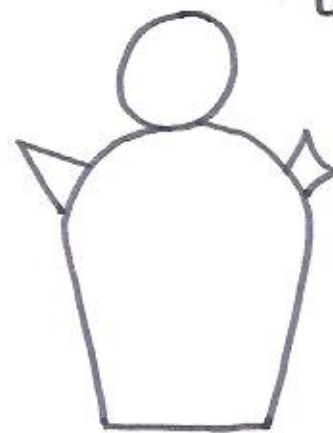

botij-



oj-



aj-

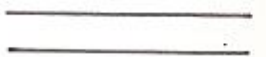
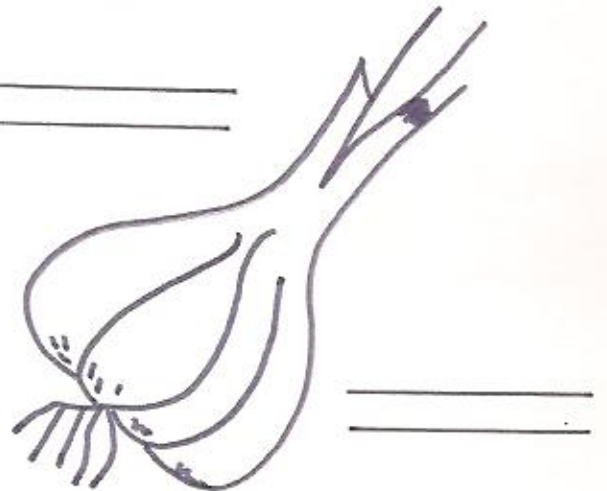
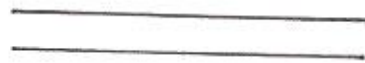
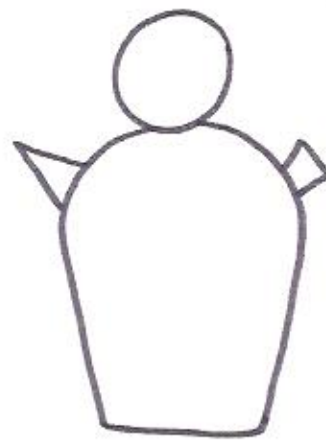
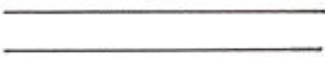
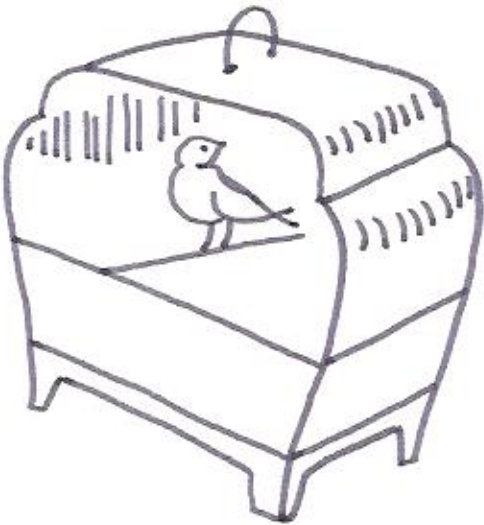
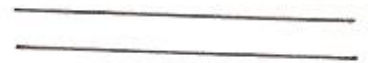
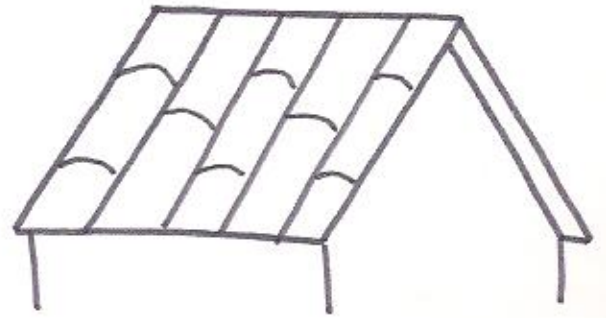
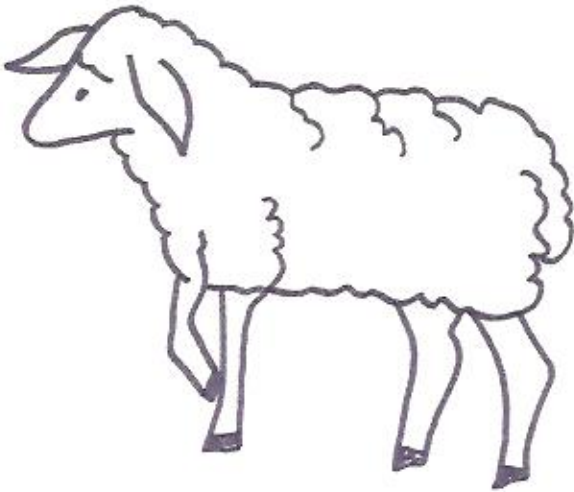
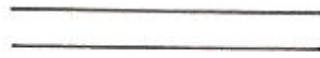
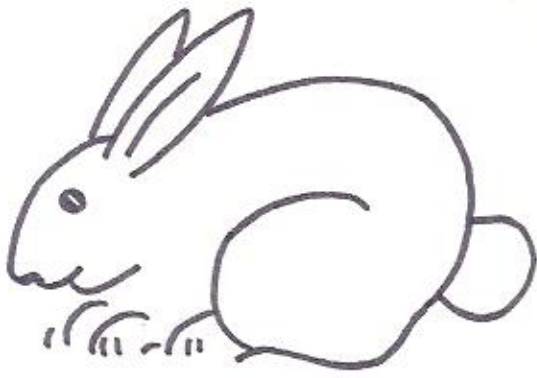

jota gota caja gorila
galleta majo jaca bigote

j

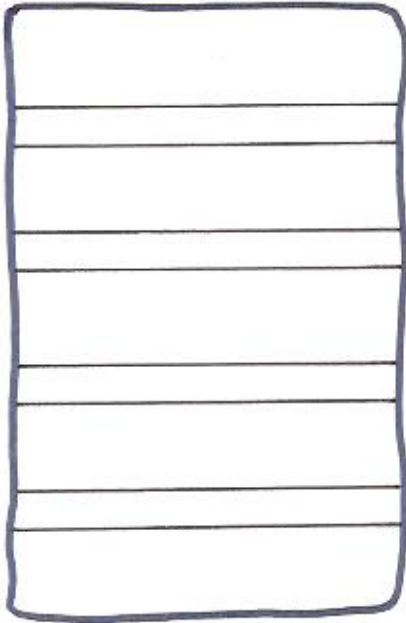

g

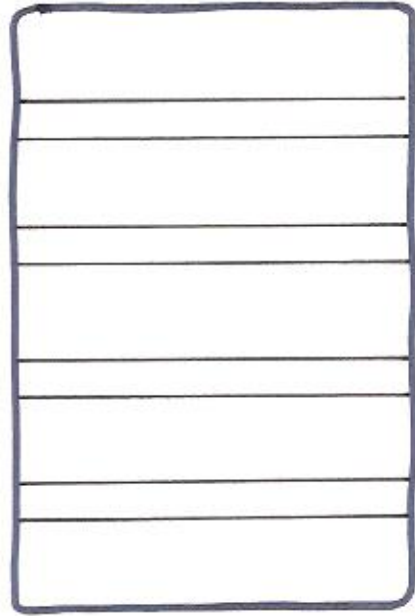

dictado

ga		go		gu
----	--	----	--	----

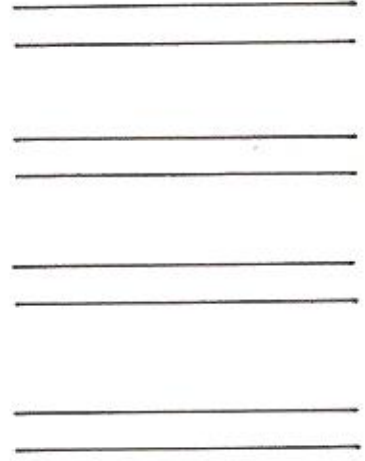
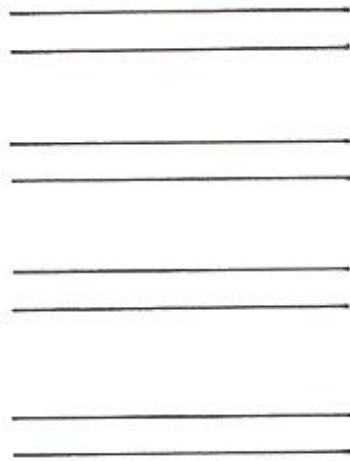
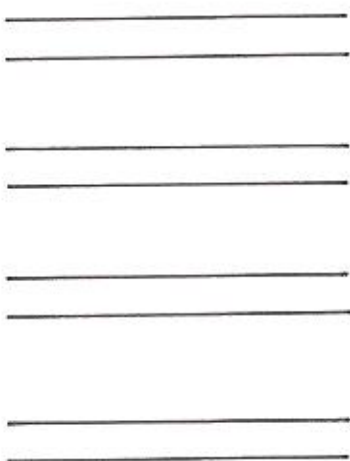



gallina

gorro

gusano

garrafa

gotero

cigarro

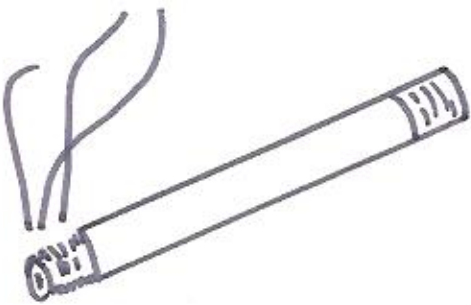

g-to

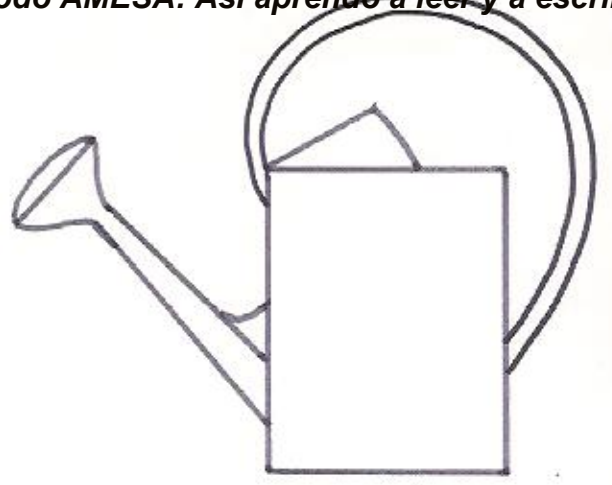
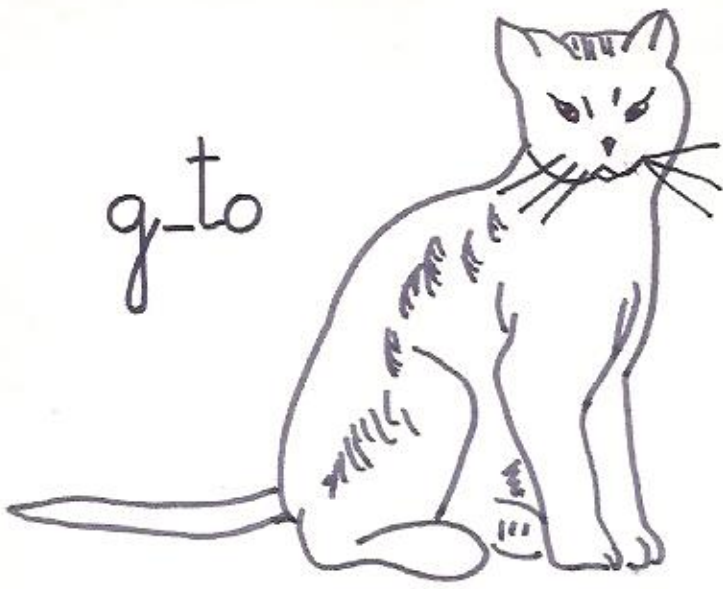

reg-der-

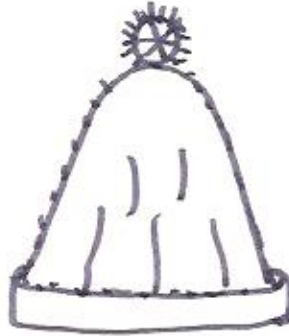

g-rrro



g-llin-



g-rrafa

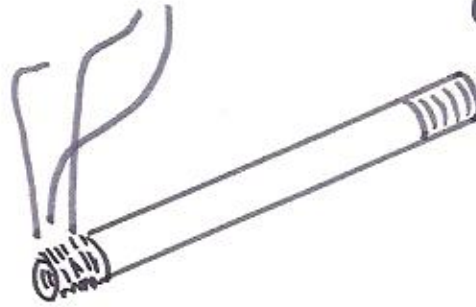

cig-rr-



ag-j-



reg-lo

g-sano



g-tero

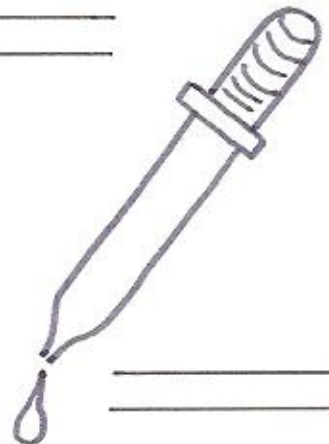
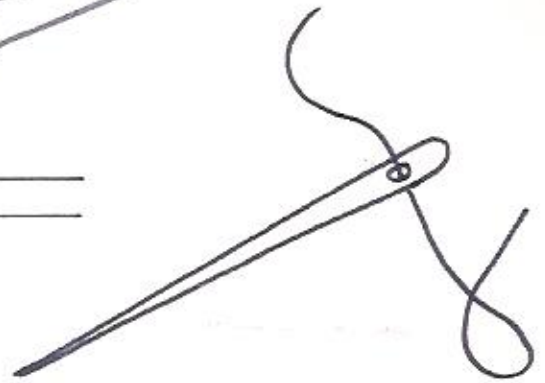
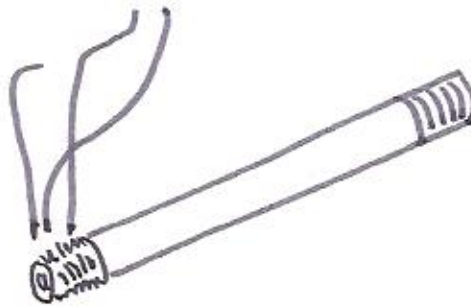
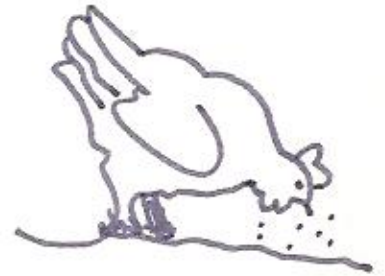
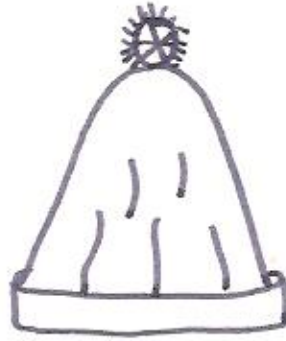
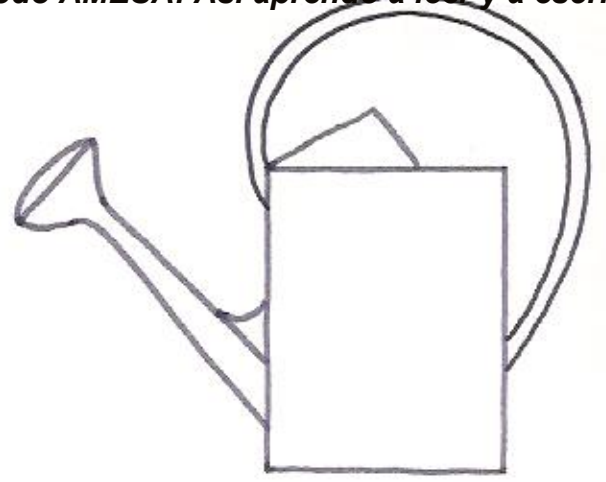
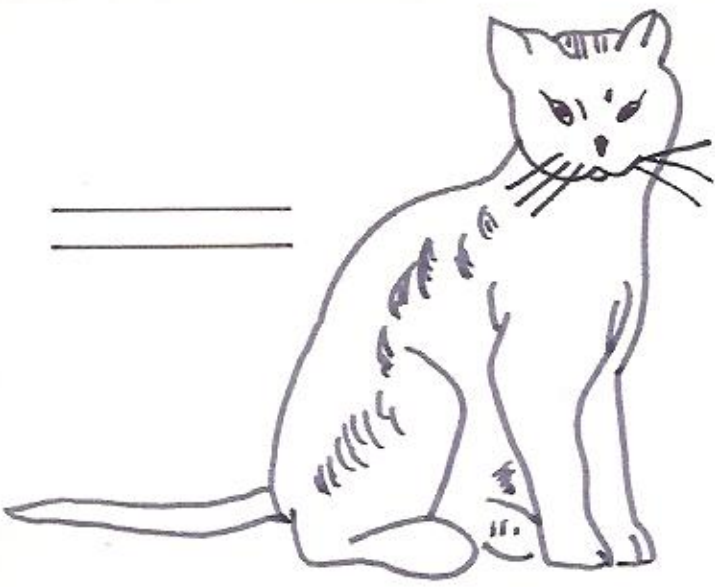

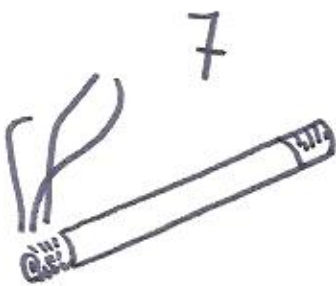
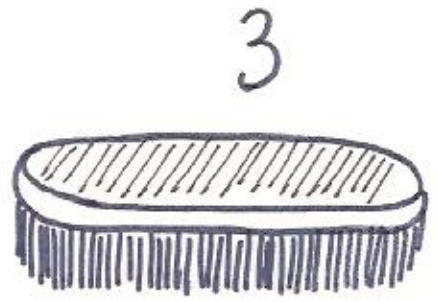
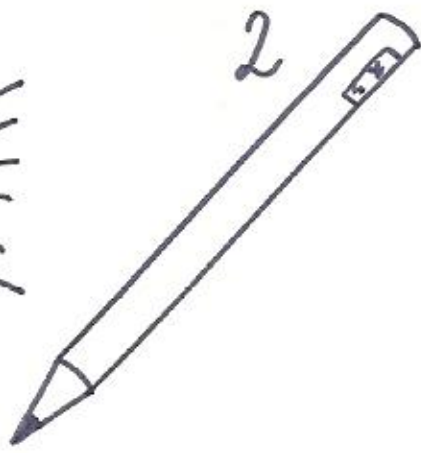
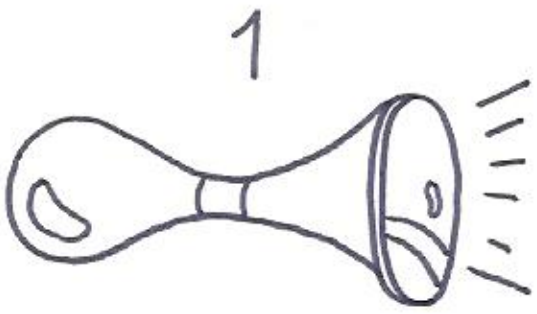

auto-dictado

1- _____

4- _____

7- _____

2- _____

5- _____

8- _____

3- _____

6- _____

9- _____

lago goma quieto gaita
queso mago quita equipo

↓
q

↓
qu

dictado

	que		qui	
--	-----	--	-----	--

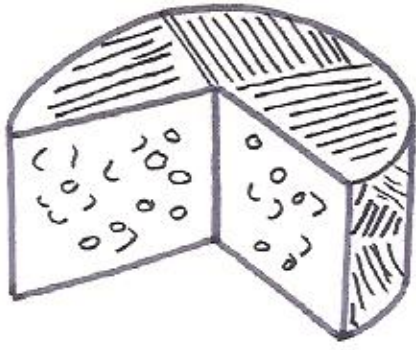

raqueta

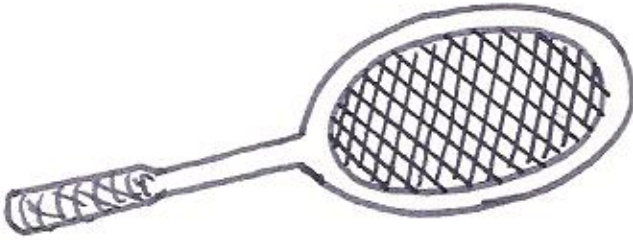

queso

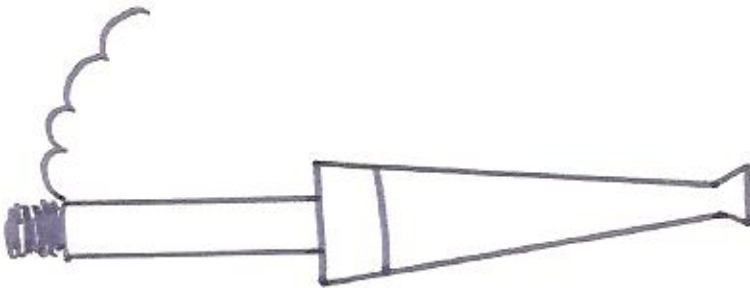

paquete

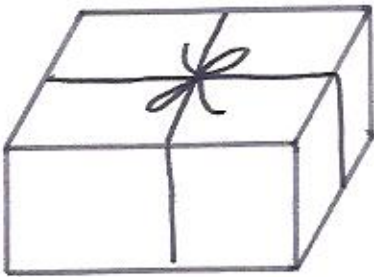

máquina

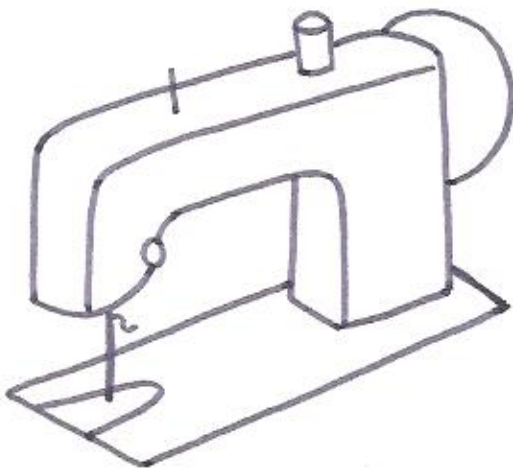

boquilla

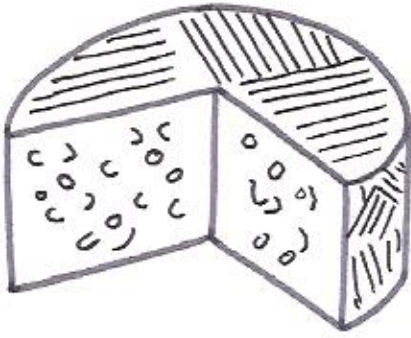

qu-so

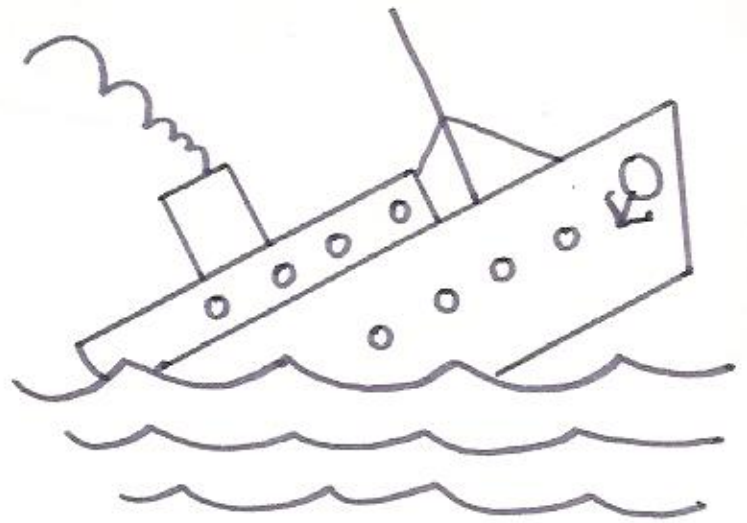

buqu-



chaqu-ta

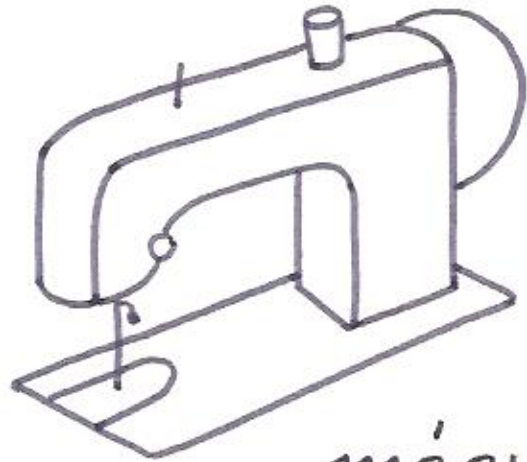

máqu-na

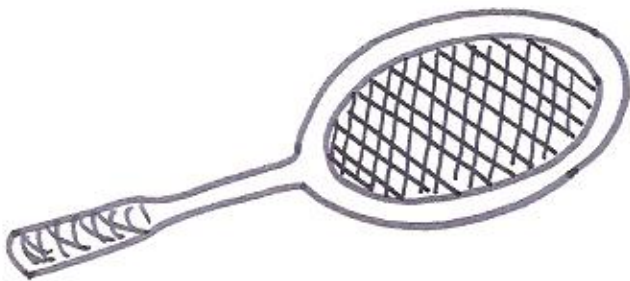

raqu-ta

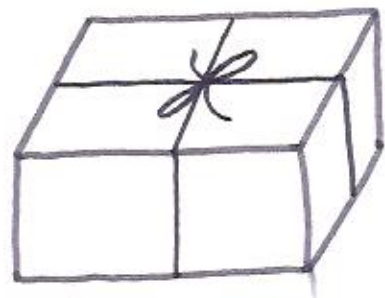

paqu-te

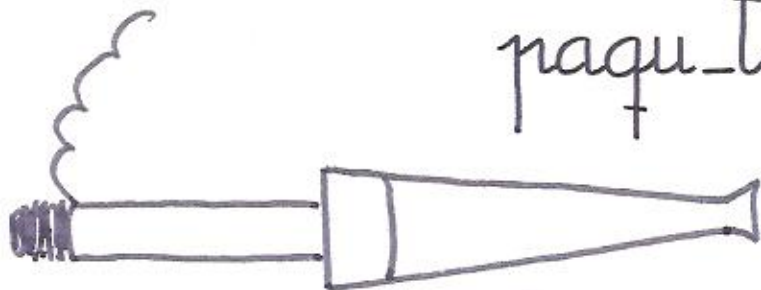

boqu-lla

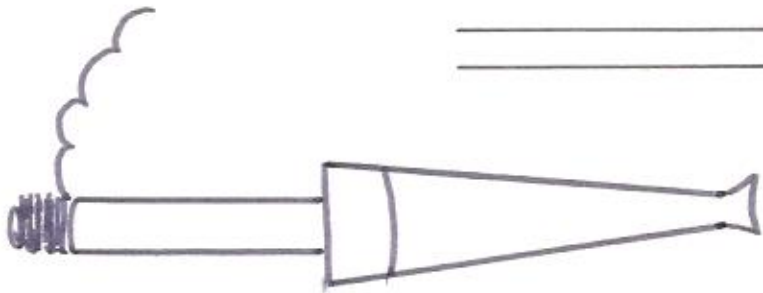
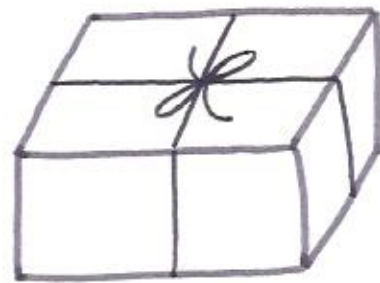
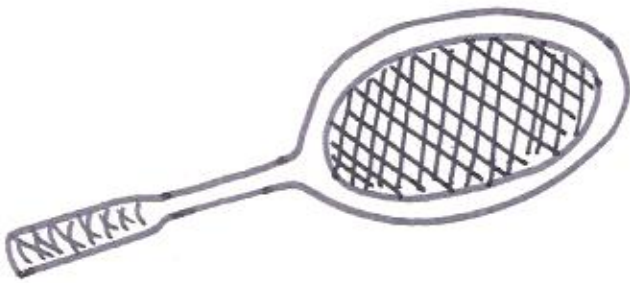
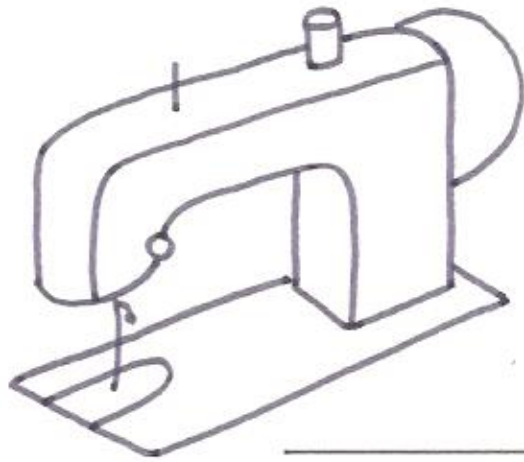
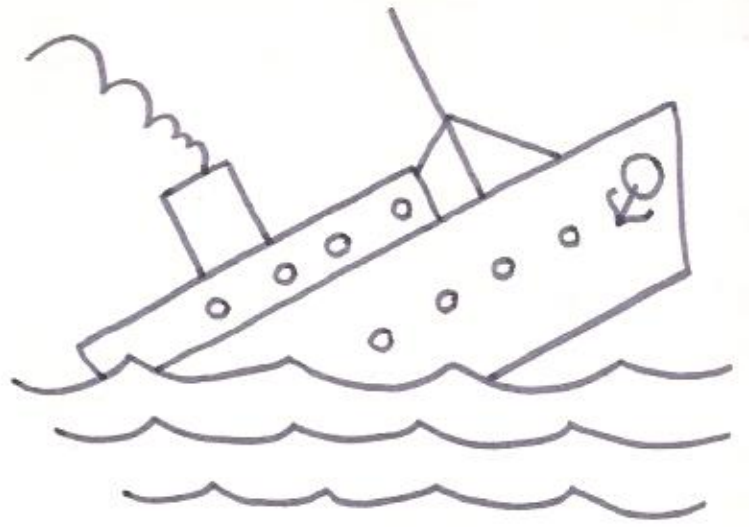
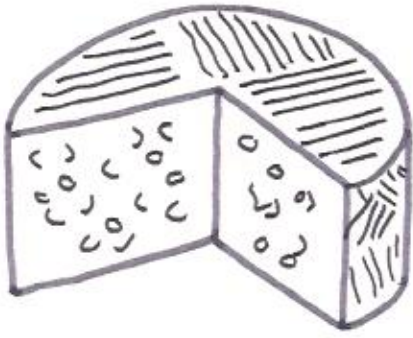

quejica maiza quemado tiza
capazo máquina zurra quema

qu

z

dictado

za		zo		zu
----	--	----	--	----



z - pato



larz -

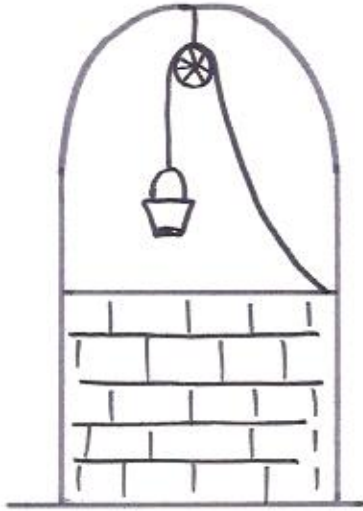

poz -

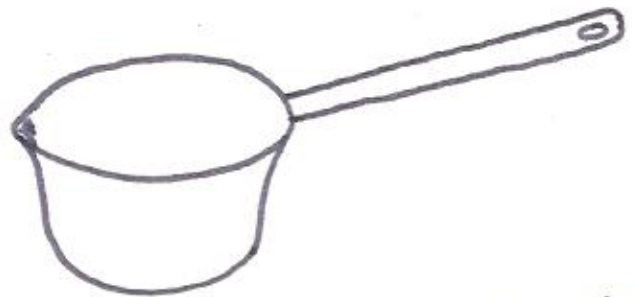

caz -



az - da

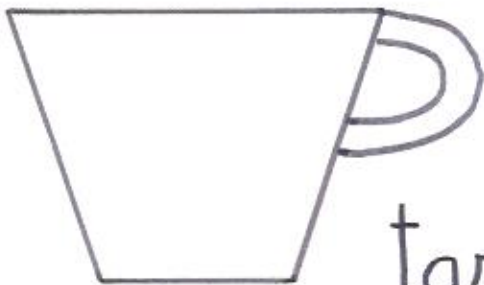

tarz -



cererz -



bruz -



==

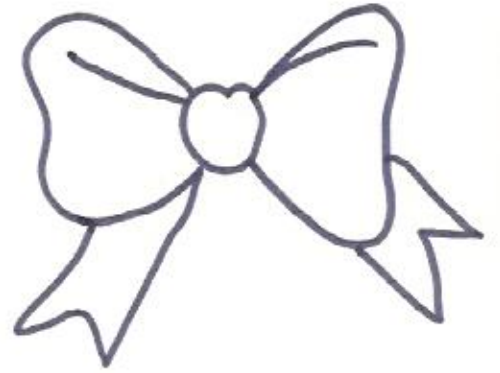

==

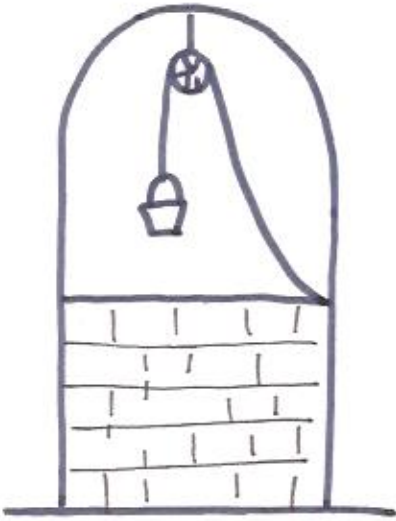

==

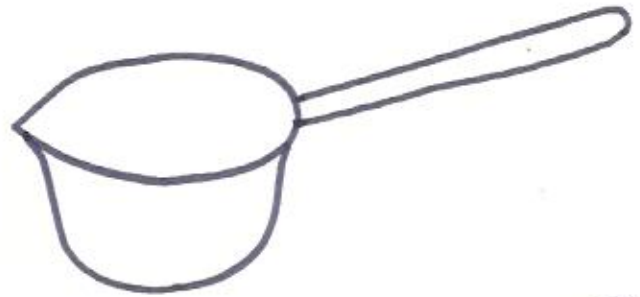

==

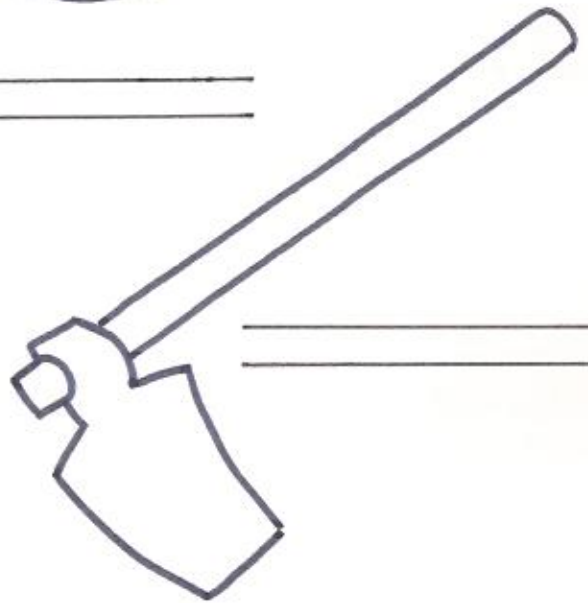

==

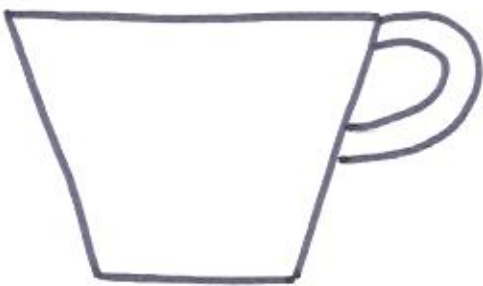

==



==

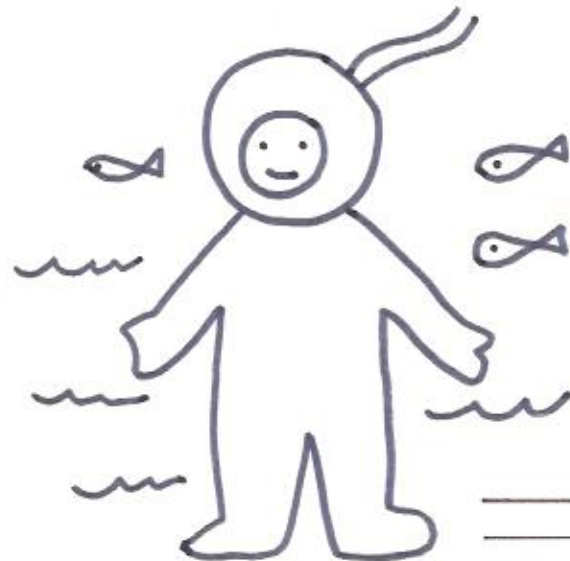

==

zorro higo harina zulú
hierro zamarrá hielo zócalo

↓
z

↓
h

dictado

ha	he	hi	ho	hu
----	----	----	----	----

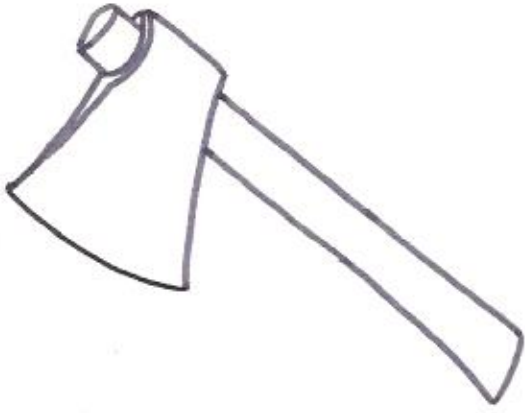

huevo



helado

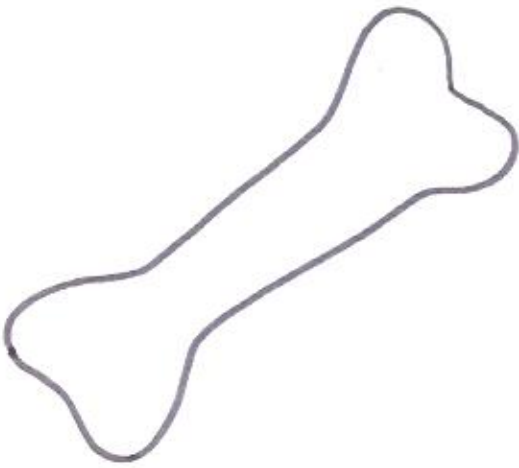

hacha

hucha

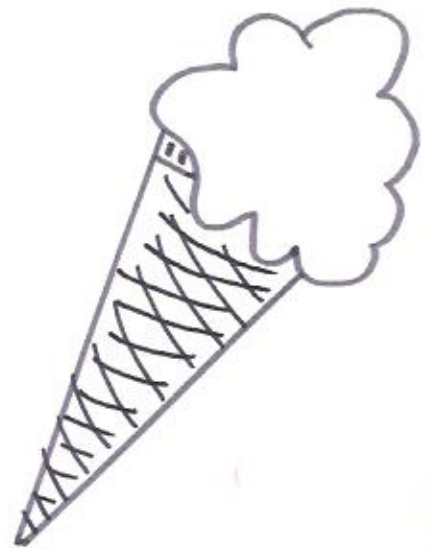

hoja



hueso



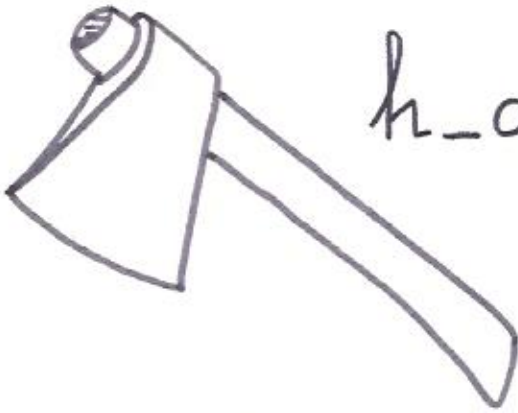

h_ cha

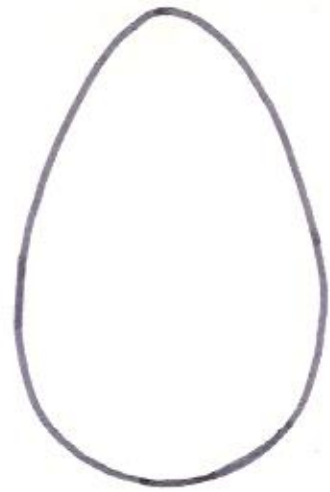

h_ ovo

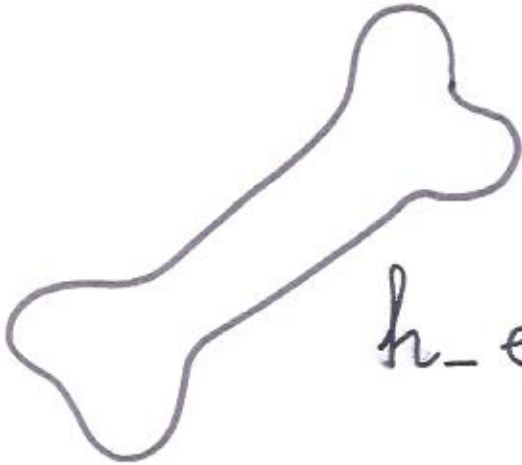

h_ eso

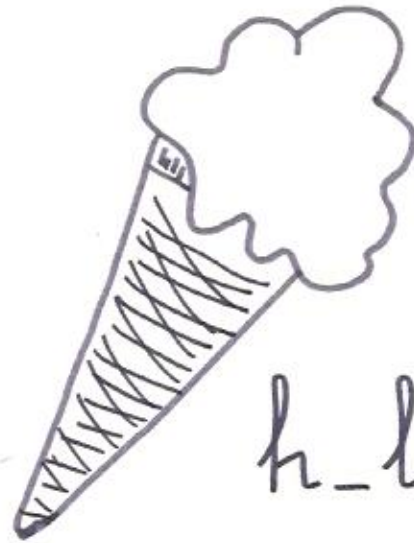

h_ lado

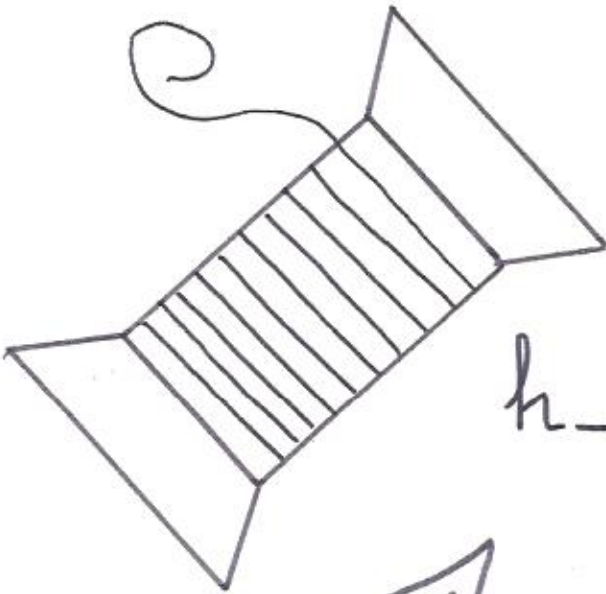

h_ lo



h_ ja

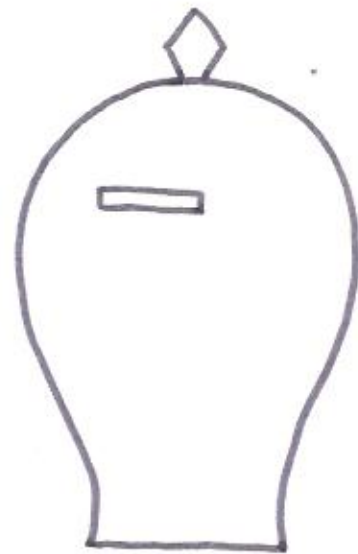

h_ cha

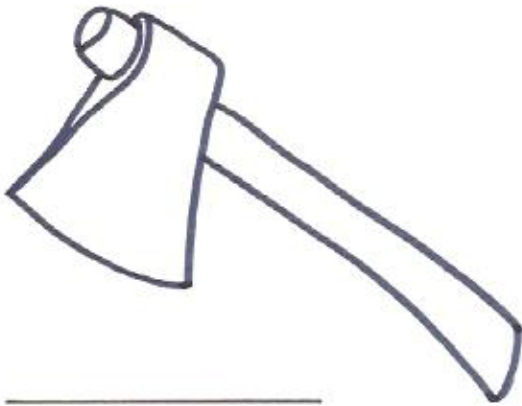

==



==

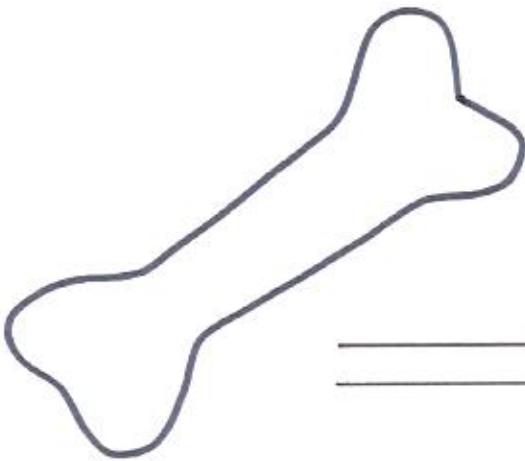

==

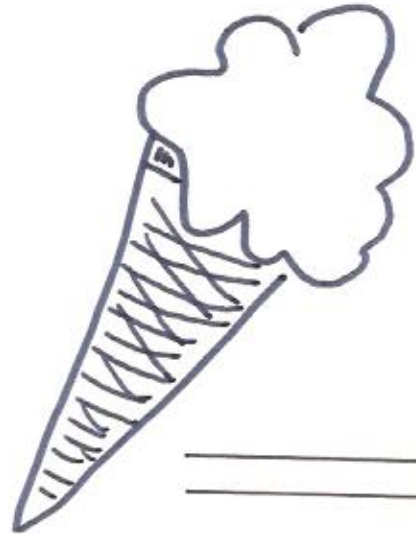

==

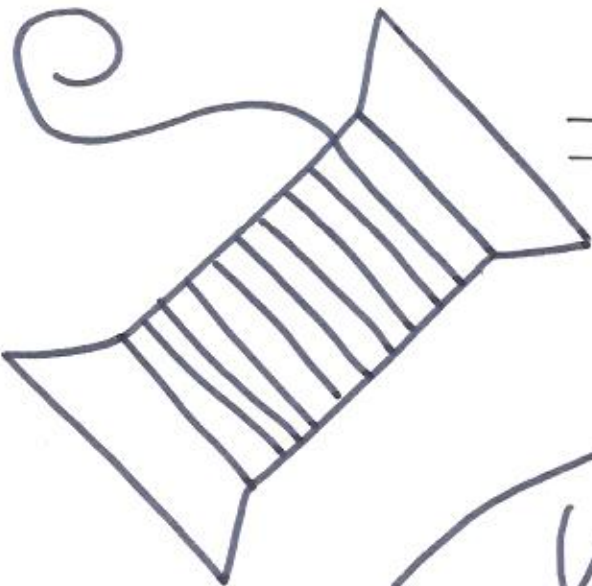

==

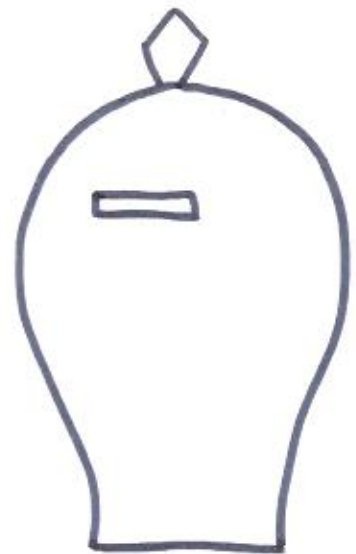

==



==

hogaza tuyo hora buho
yeso hebilla raya hélice

↓
h

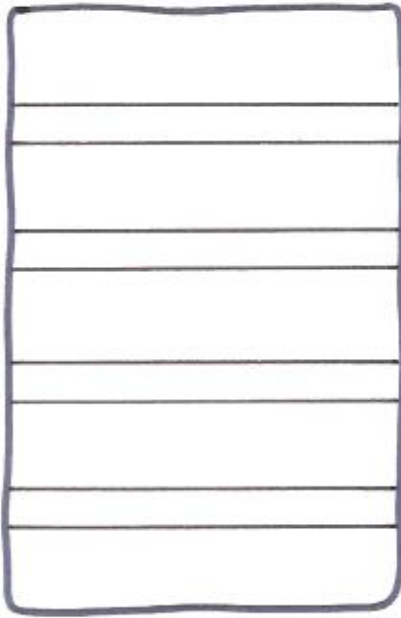

↓
y

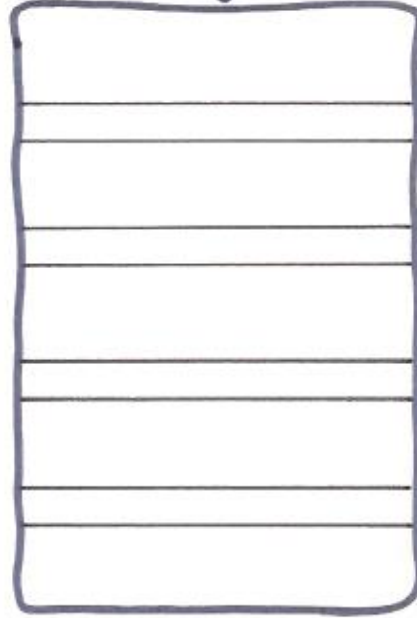

dictado

ya	ye	yi	yo	yu
----	----	----	----	----

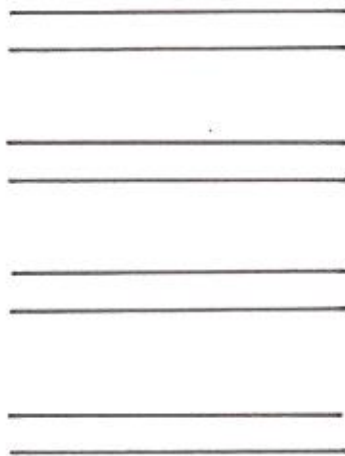
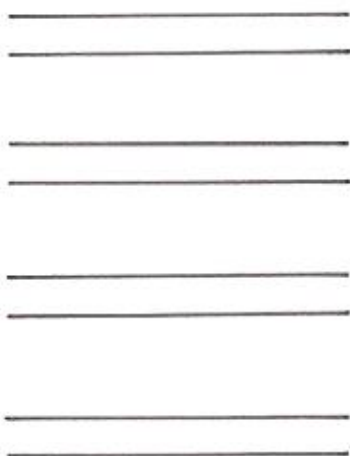

yoyo



yate

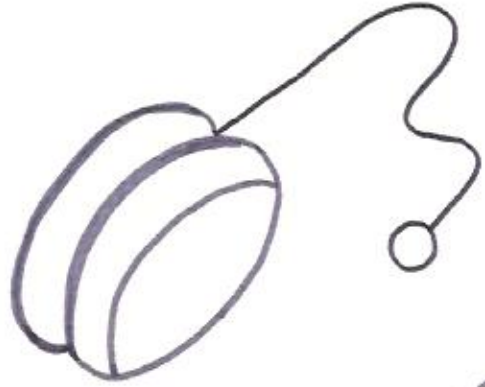

joya



yugo



bayoneta





y-te



pay-so



y-go

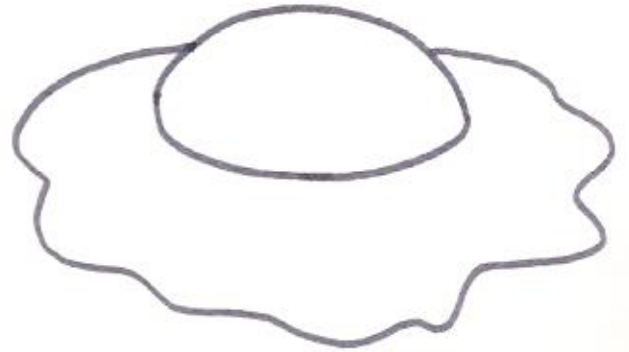

y-ma



y-y-

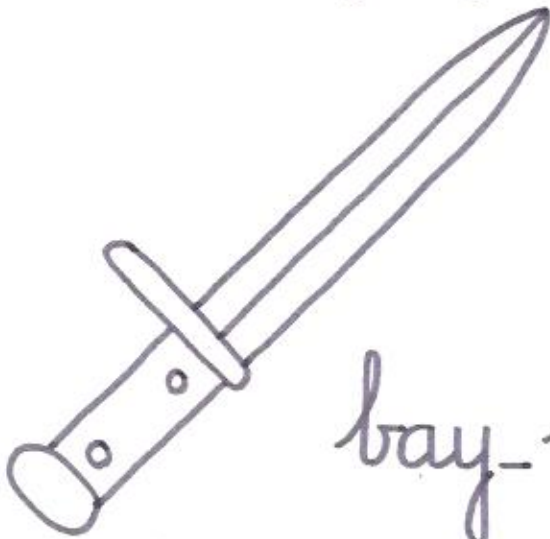

bay-neta



joy-

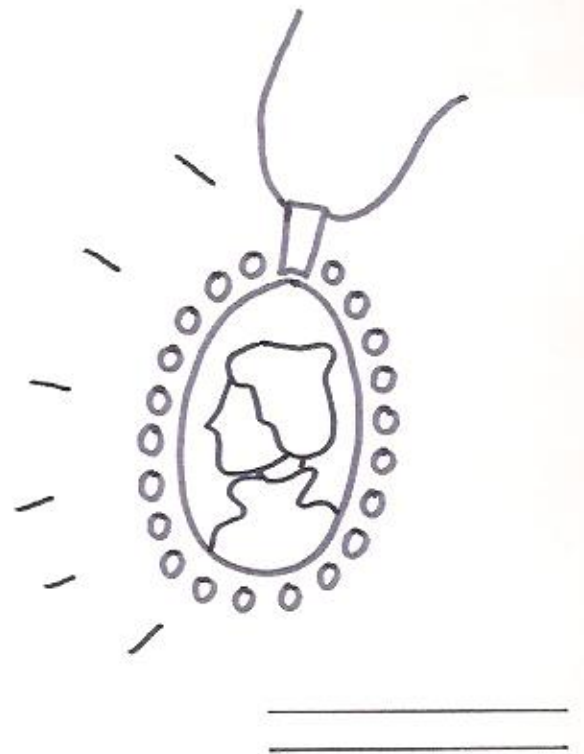
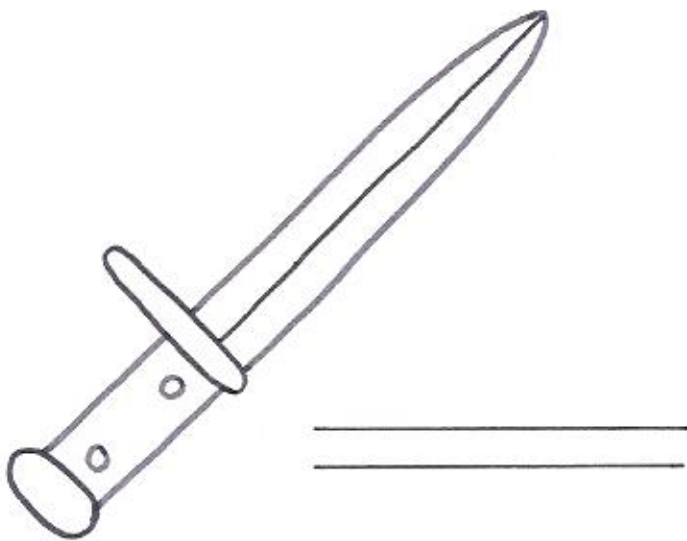
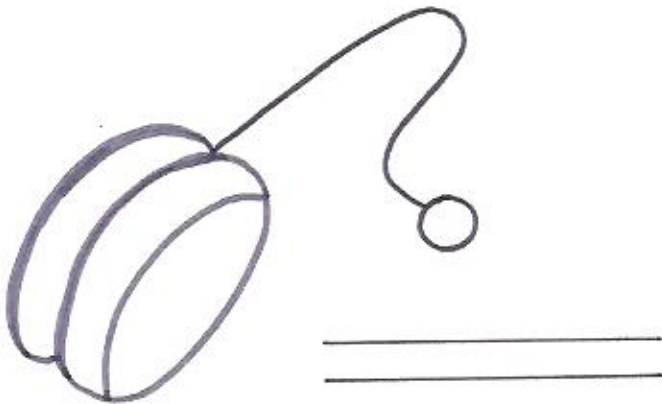
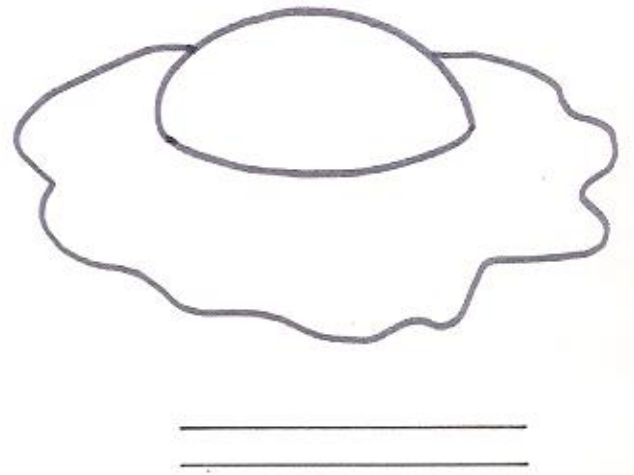
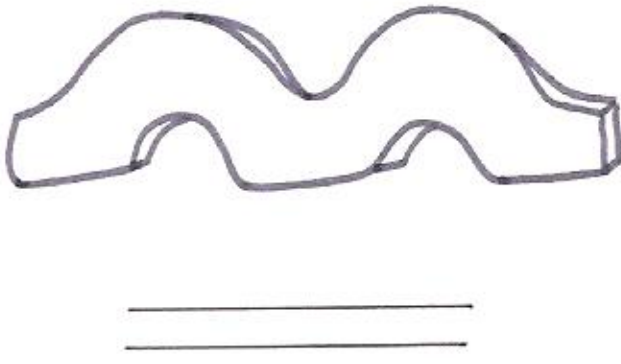
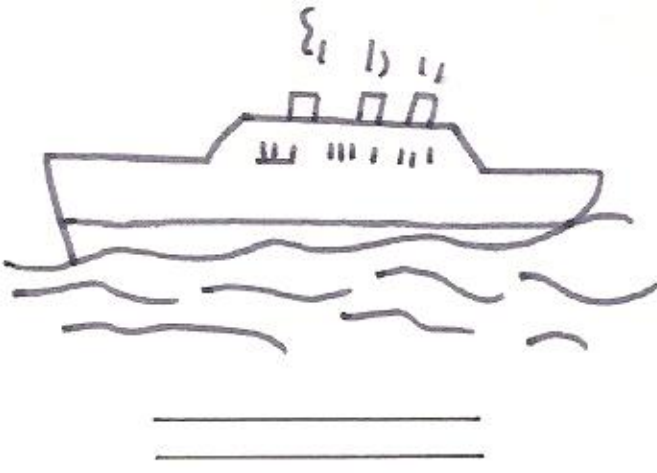

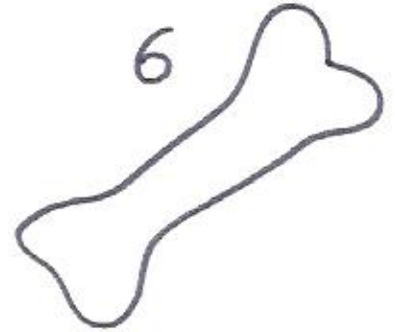
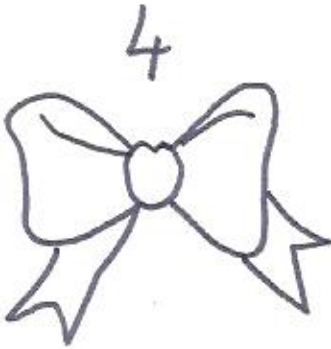
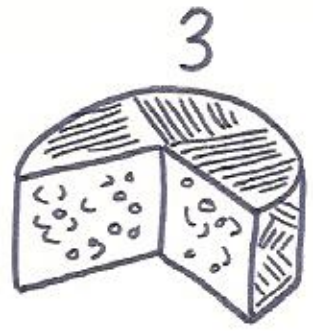
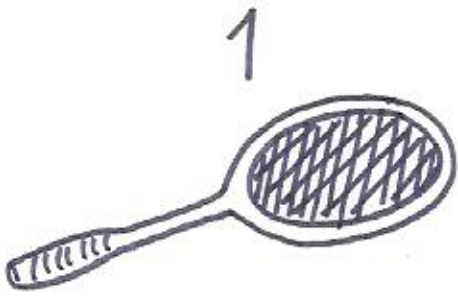

autodictado

1. _____

4. _____

7. _____

2. _____

5. _____

8. _____

3. _____

6. _____

9. _____

ayuda ligero gitano yema
yate gema payaso gemelo

y

ge-gi

dictado

	ge		gi	
--	----	--	----	--

gitano

giba

geranio

gemelo

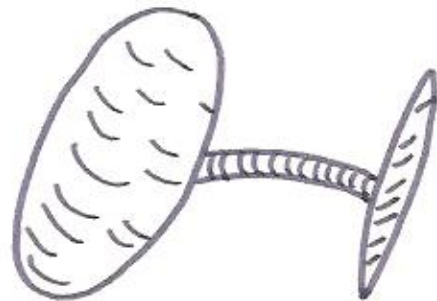
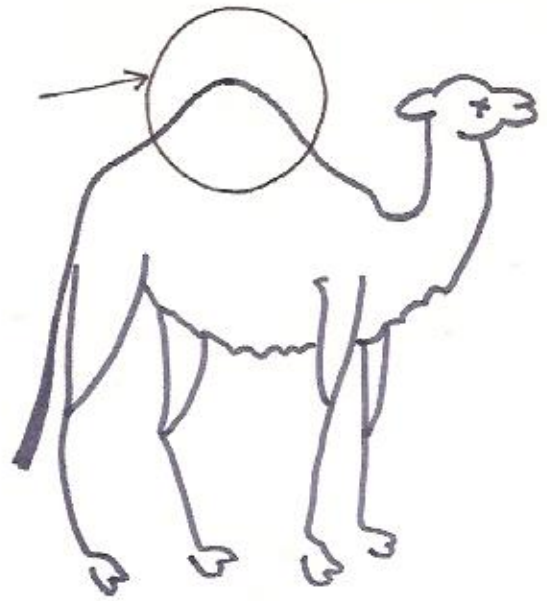

q_ba

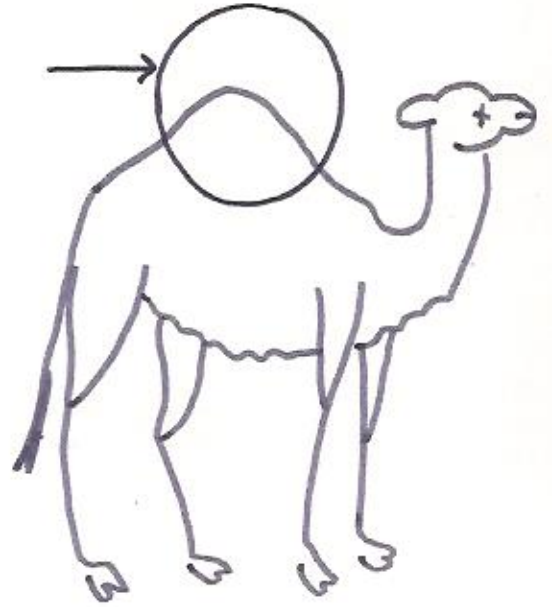

q_tano



q_ranio

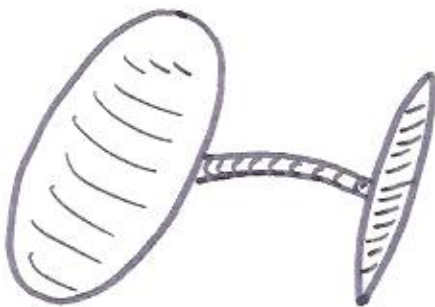

q_melo

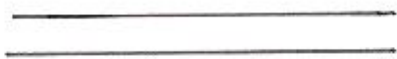
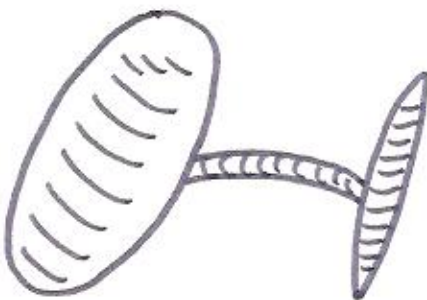
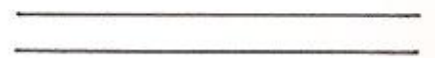
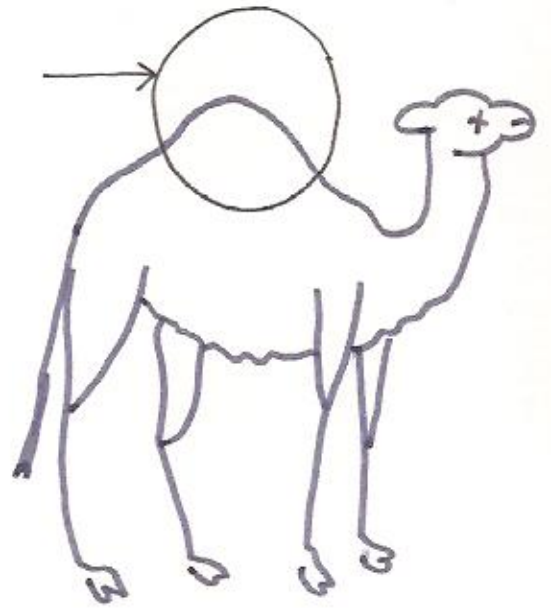
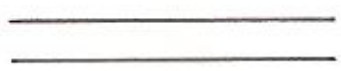

gitana guitarra genio quia
giro magia águila juguete

ge-gi

que-qui

dictado

	que		qui	
--	-----	--	-----	--

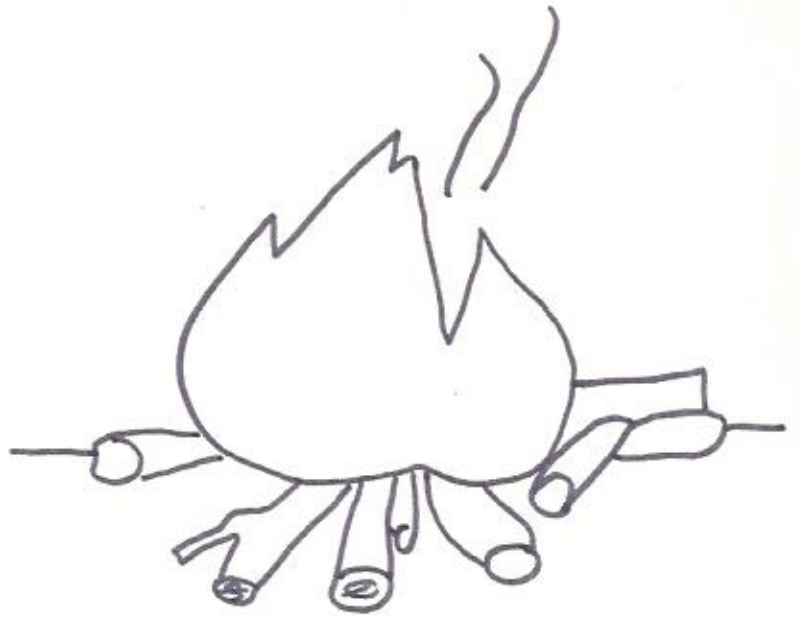

hoguera

guitarra

quiña

águila

quisa

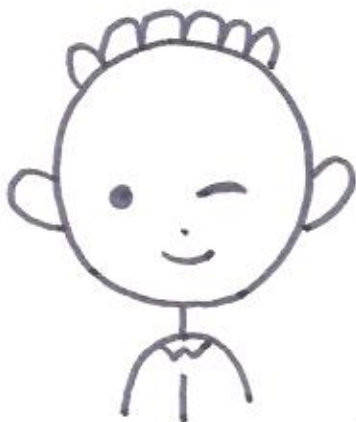



gu-tarra

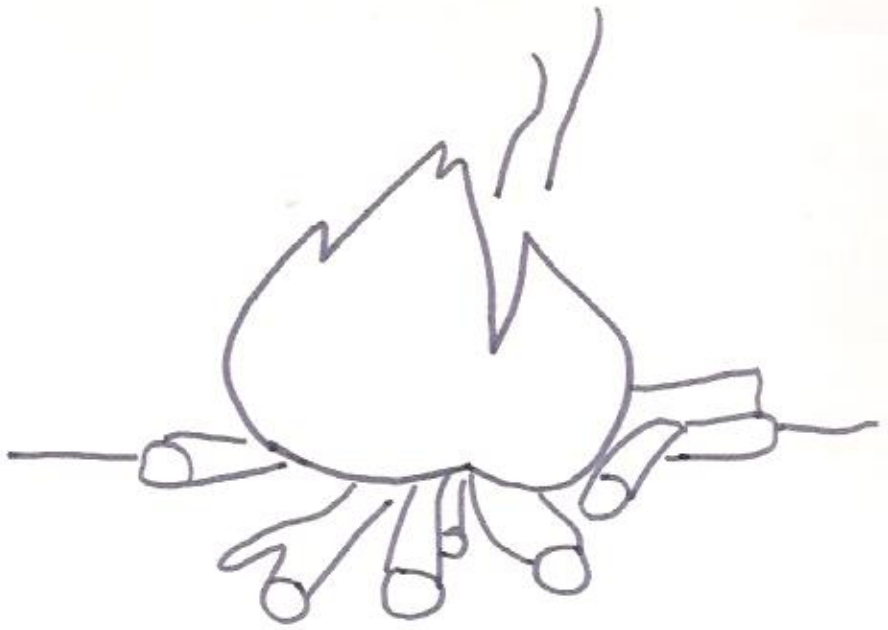

hogu-ra



gu-sa

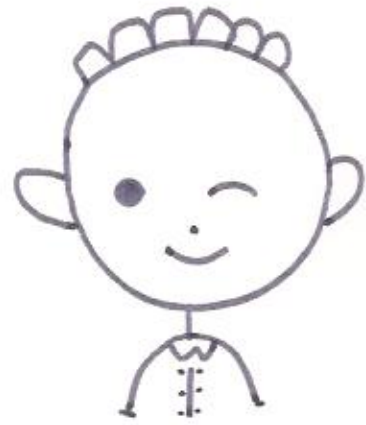

gu-ña



águ-la



==

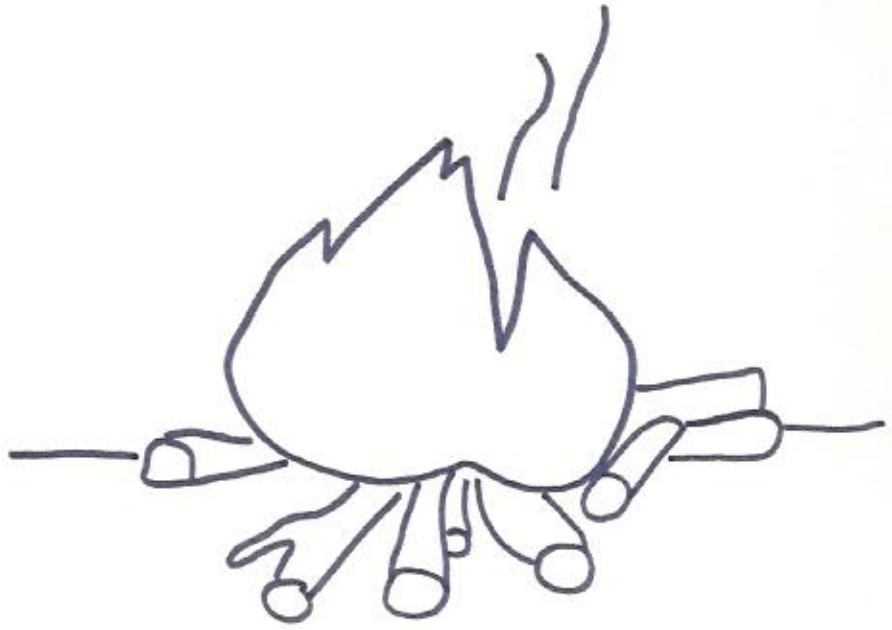

==



==

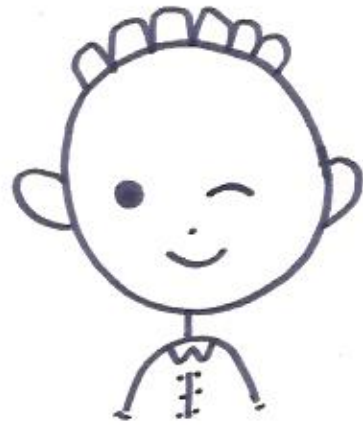

==



==

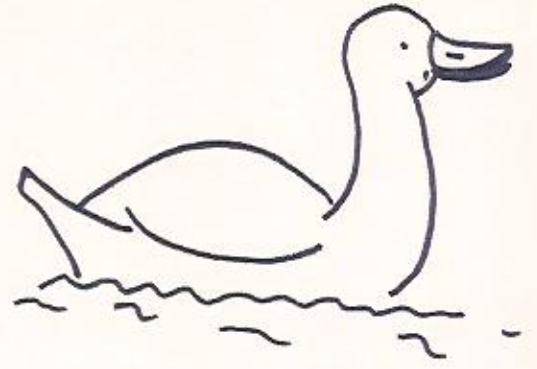
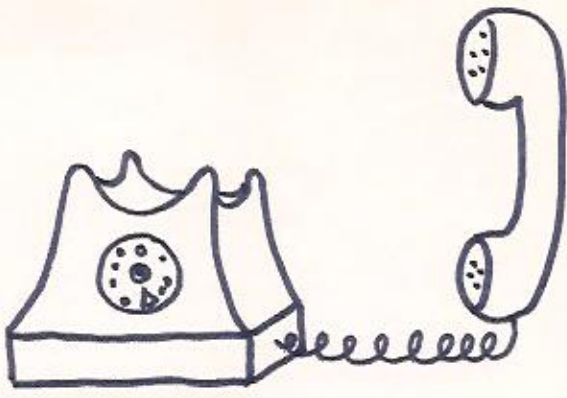

pato
pelota
teléfono
peine
sapo
bota
botella
dedo
llave

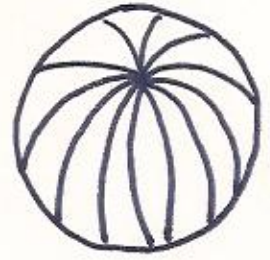

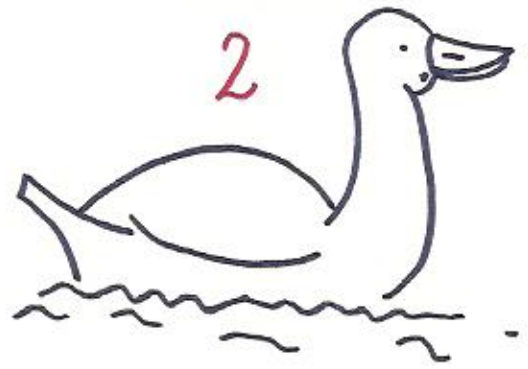
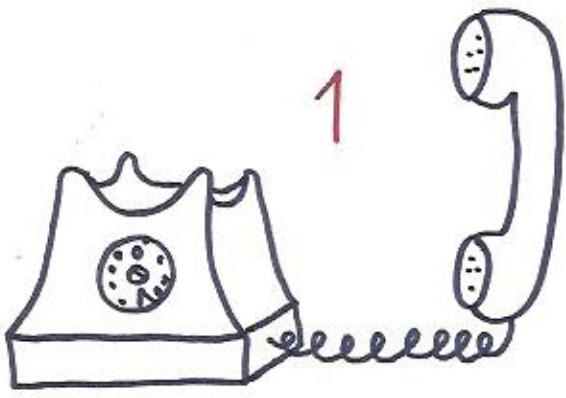

1- _____

2- _____

3- _____

4- _____

5- _____

6- _____

7- _____

8- _____

9- _____

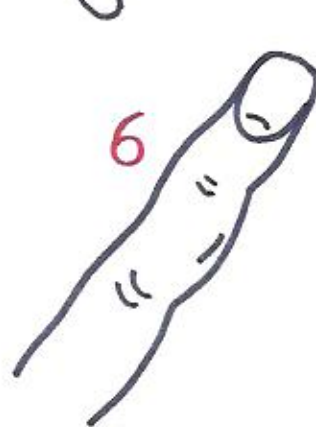
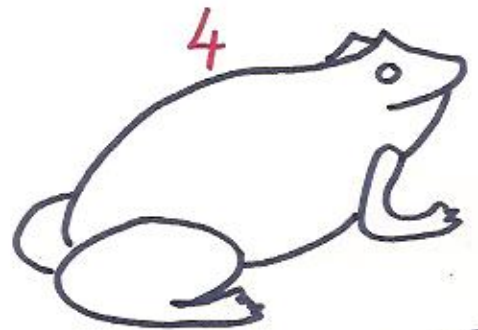

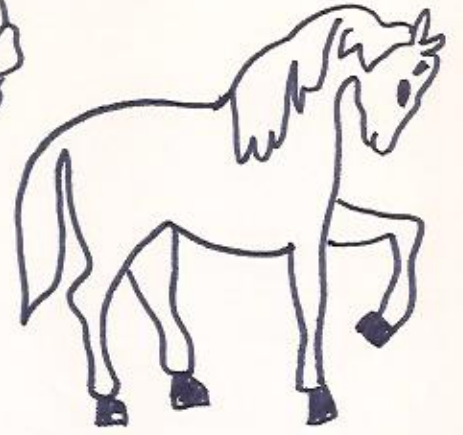
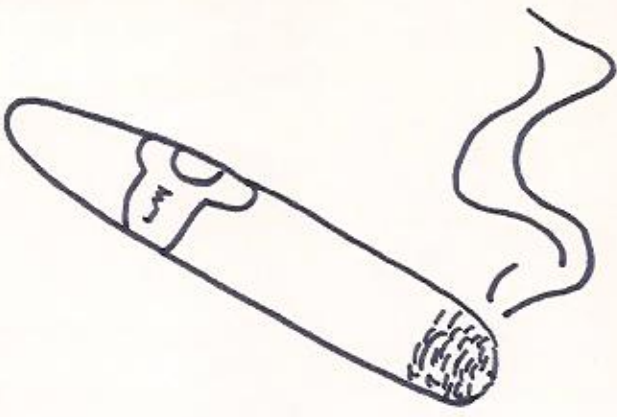

puro
chupete
niña
caballo
chorro
rata
rosa

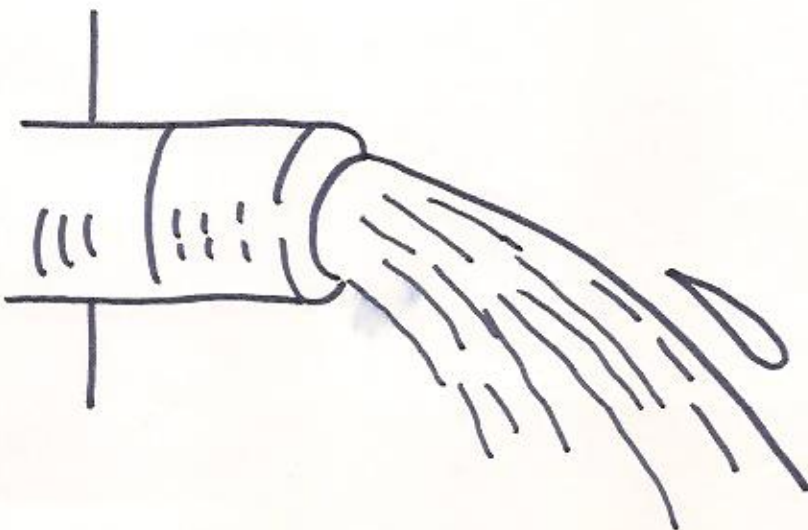
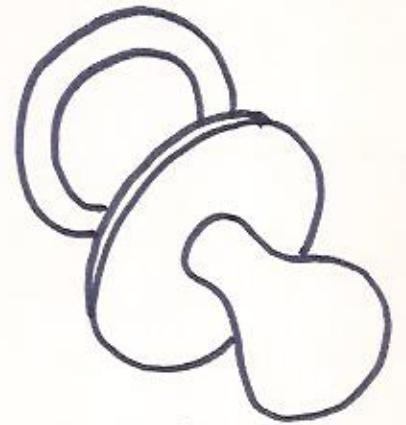

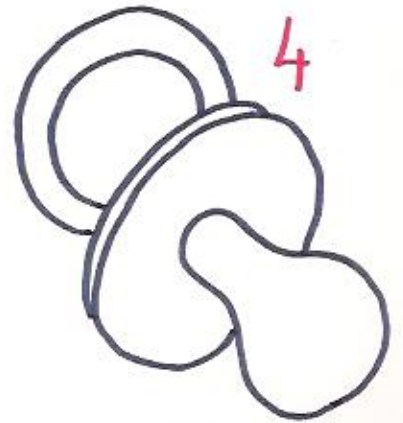
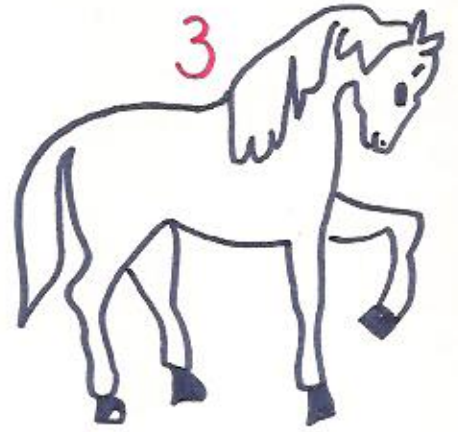
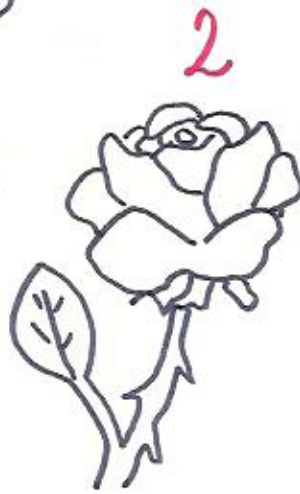
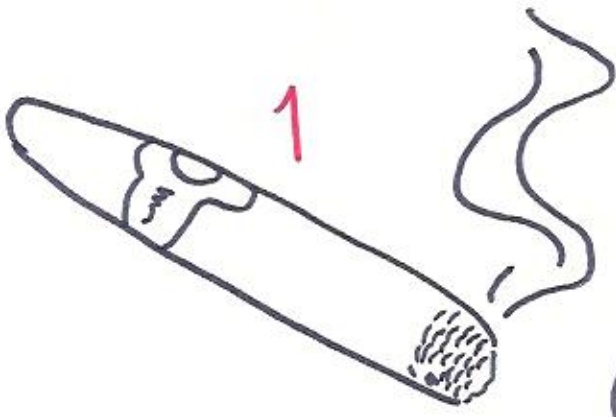

1- _____

2- _____

3- _____

4- _____

5- _____

6- _____

7- _____

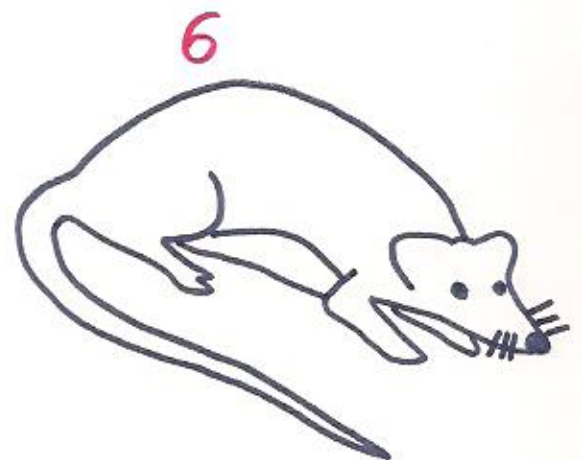



cerilla

payaso

conejo

chaqueta

hueso

lazo

cigarro

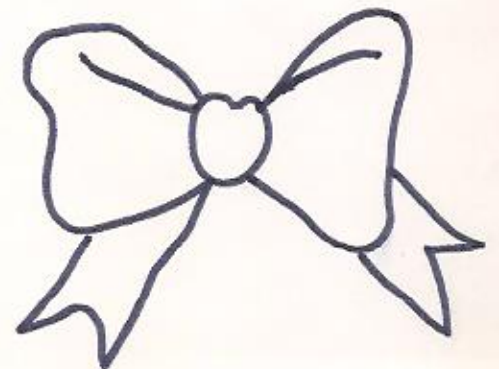
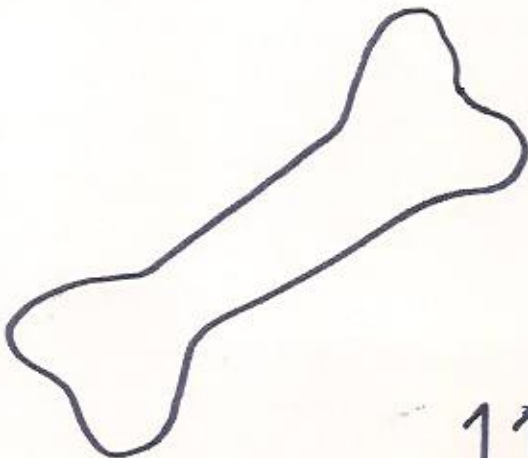
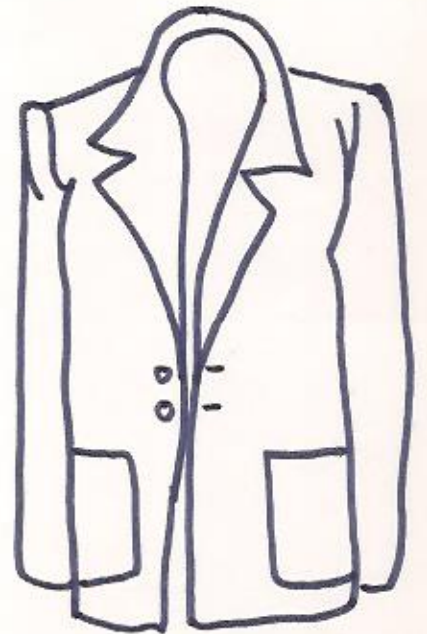
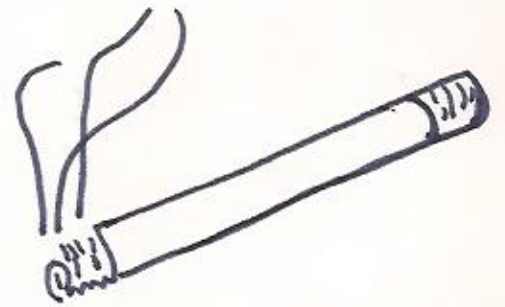



1. _____

2. _____

3. _____

4. _____

5. _____

6. _____

7. _____

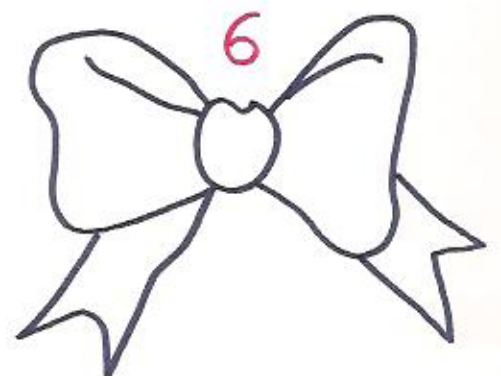
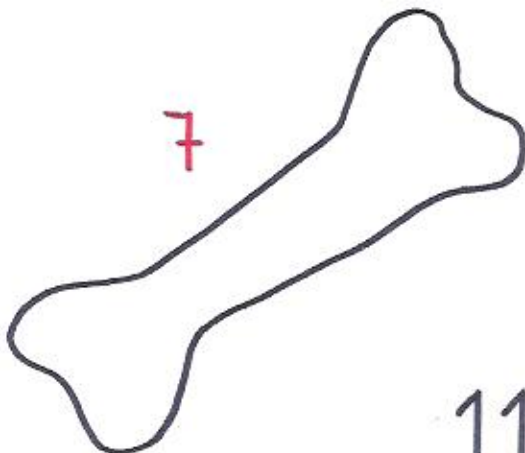
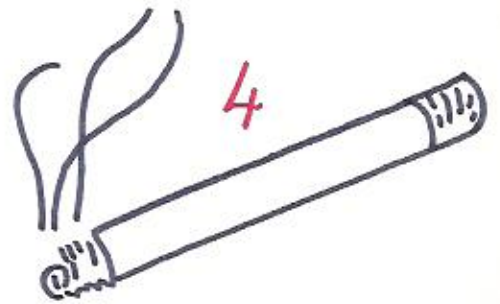

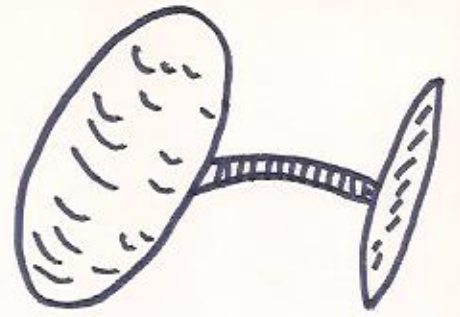
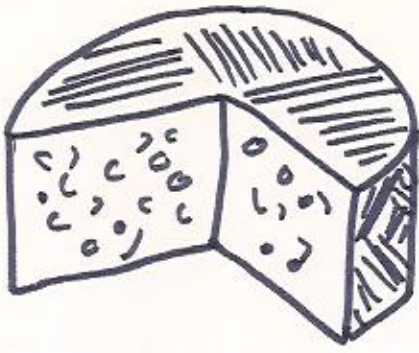

águila

queso

gemelo

zapato

helado

yema

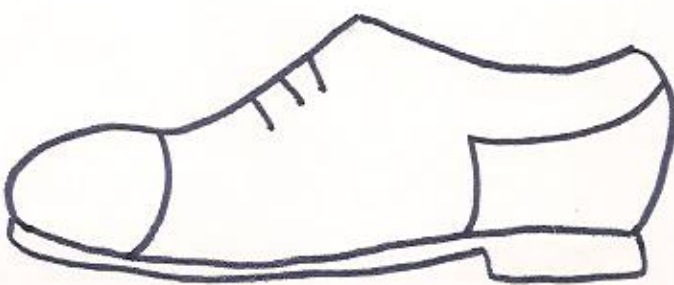
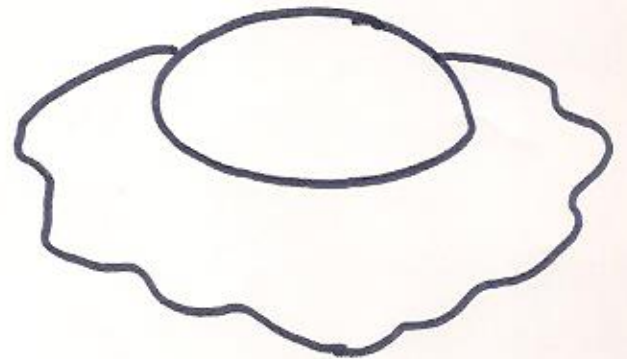

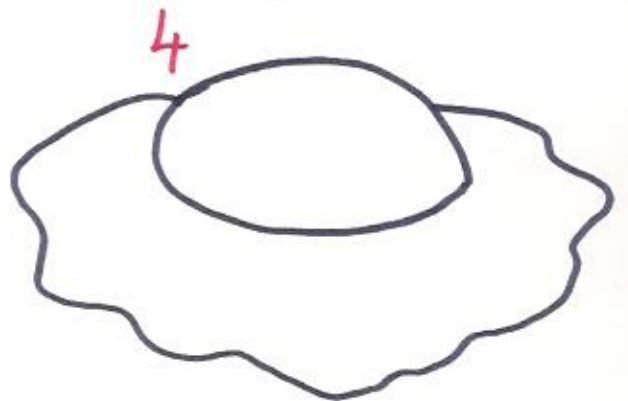
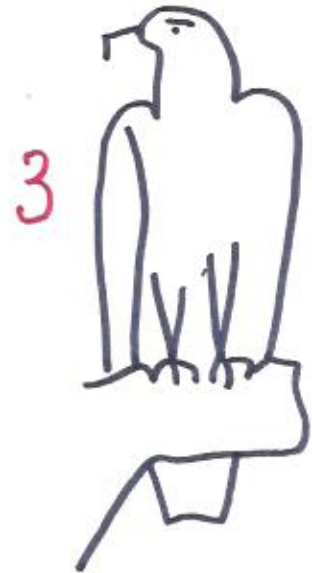
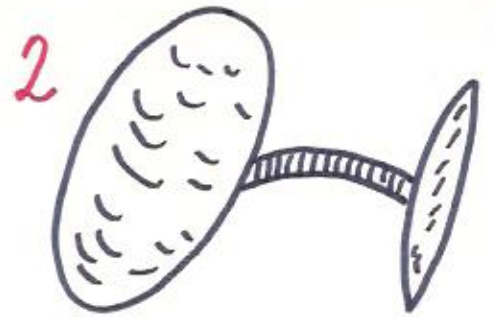
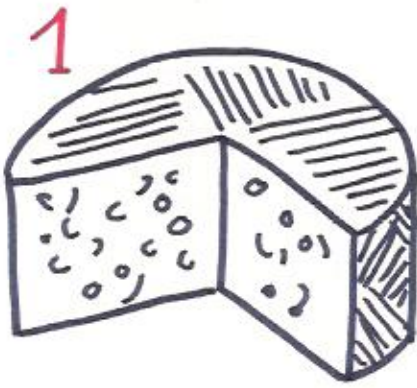

1- _____

2- _____

3- _____

4- _____

5- _____

6- _____

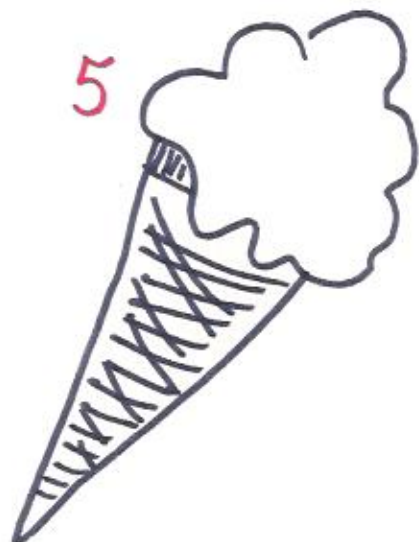
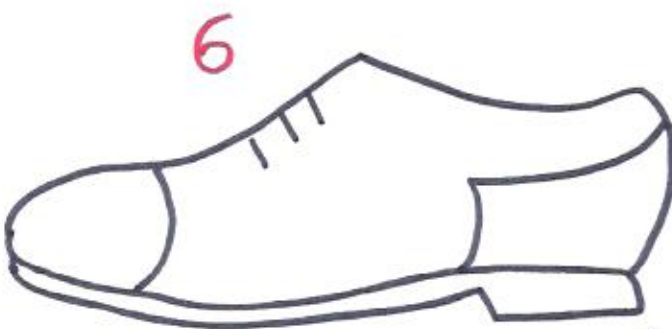



Blank writing lines

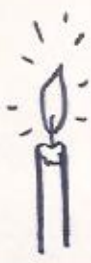

Blank writing lines



Blank writing lines



Blank writing lines



Blank writing lines



Blank writing lines



Blank writing lines



Blank writing lines

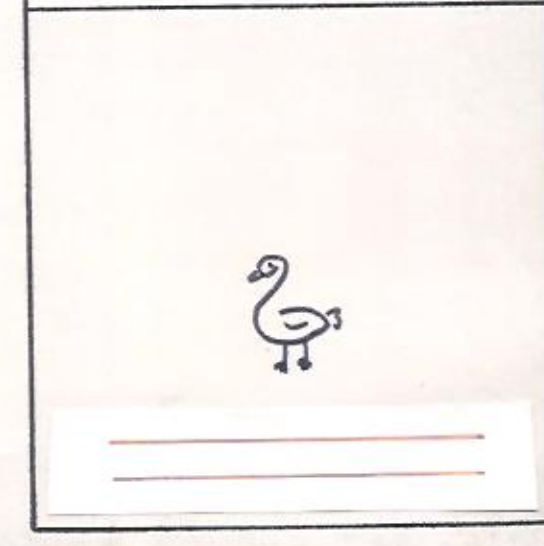
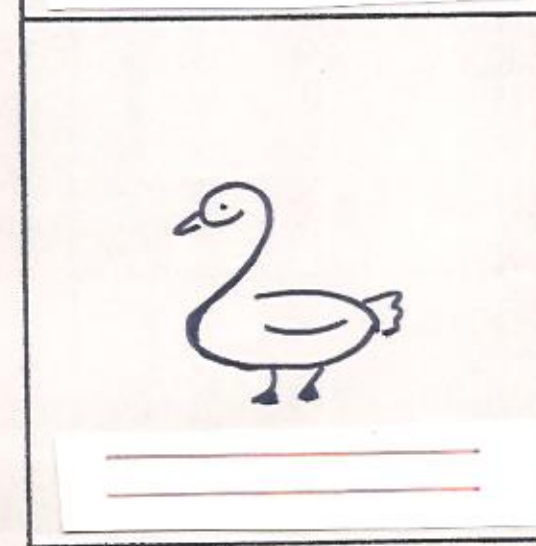
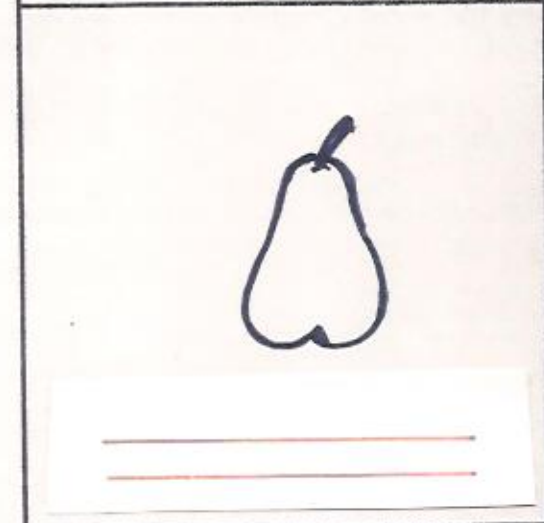
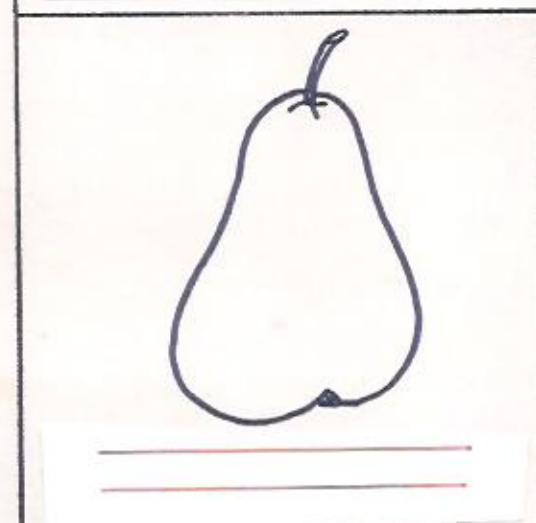
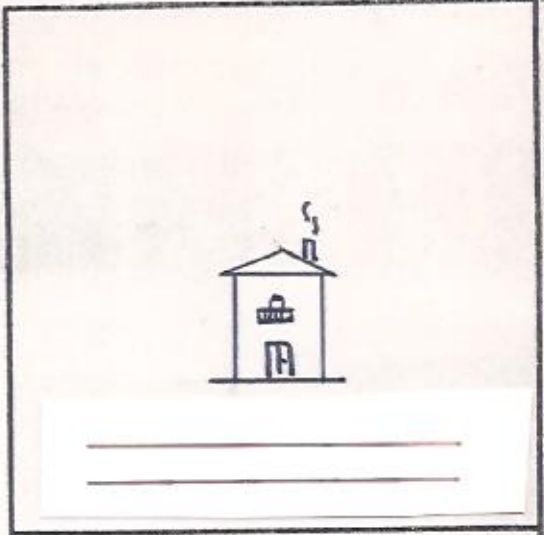
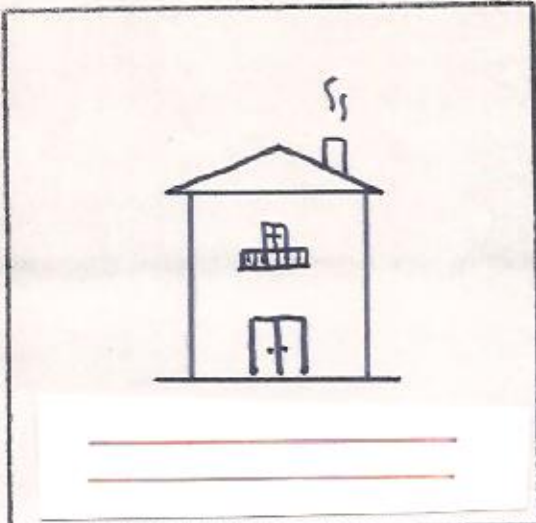

Completar:

gitano → gitanito

sello → _____

chino → _____

burro → _____

gusano → _____

hilo → _____

rama → _____

Relacionar

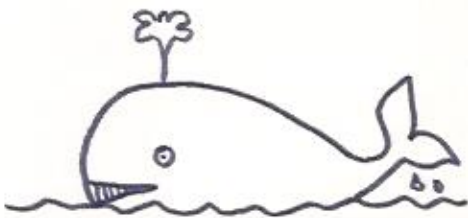

jarra

toro

ballena

perro

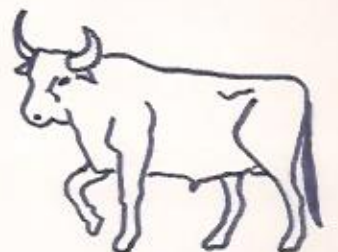

Completar

caja → cajita

lima → _____

dedo → _____

tubo → _____

botella → _____

caña → _____

gato → _____

Relacionar:



garra

cubo

queso

conejo



Completar:

gato → gata

perro → _____

pavo → _____

oso → _____

zorro → _____

burro → _____

Relacionar



abanico

anillo

taza

foca



Completar

niño → niña

conejo → _____

lobo → _____

muñeco → _____

gallo → _____

chino → _____

Relacionar

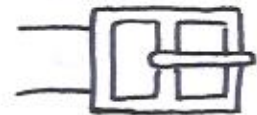

hebilla

pico

racimo

choza



Completar

enano → enana

papá → _____

toro → _____

palomo → _____

caballo → _____

mono → _____

Relacionar

1

7

nueve

uno

siete

cero

127

0

9